

NEPLAN®

Smarter Tools

Power System Analysis Software



NEPLAN one of the most complete planning, optimization and simulation tool for transmission, distribution, generation and industrial networks.

Reliable – Efficient – User-friendly



Data management

- Most intuitive Graphical User Interface
- Multi-document and multi-window system
- All equipment can be entered graphically and/or table oriented (like in a excel sheet)
- There is no restriction on drawing sizes and number of nodes and elements.
- Extensive editing functions like undo, redo, delete, copy, move and zoom for processing the network diagram are available. An element can be moved from one node to an other node without deleting the element.
- OLE functionality: Data and graphic can be moved to and from third party software (like MS-Excel, MS-Word). Project documentation was never easier.
- The equipment data are entered in dialogs, with plausibility checks provided. A coloring tool helps to show which data is needed for which analysis (e.g. short circuit, transient stability etc.)
- Integrated Variant Manager (insert, delete, append, compare variants, compare results, etc.).
- ASCII file or SQL database oriented import/export functions for exchanging network data, topology data and load data are available.
- Interfaces to external programs (e.g. measured data) can be implemented.
- Import of a geographic map as a background graphic, for easier schematic capturing.
- Import of almost any raster and vector graphic files (e.g. PCX and DXF files).
- Graphics can be exported as raster files (e.g. JPG, which can be used in any internet web browser).
- Option for combining and separating networks. Any number of independent network areas and zones are possible. Each element and node can belong to any independent area and zone.
- Extensive functions for network statistics and network documentations are available.
- A state of the art library manager with extensive libraries for each element type facilitates data entry.
- All computation modules access a shared database.
- Integrated chart manager allows to analyze and compare all results from all variants.
- Multi-lingual Graphical User Interface.

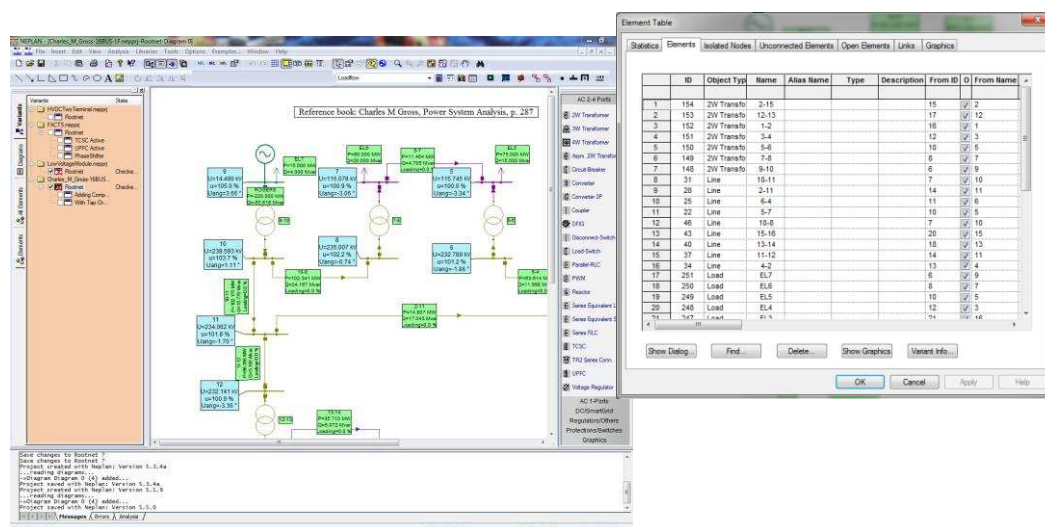

Variant Management

- Non-redundant storage and management of variants.
- For each network, you can select
 - * any desired switch states (topology file)
 - * any desired loading states (loading file)
- For each network you can define and store any desired number of variants and subvariants (variant tree). In the variant data, only the differences from the parent variant are saved.
- Variants can be compared, merged and deleted.
- The diagrams of different projects and variants can be displayed at the same time
- Results from two different variants can be displayed on the diagram in one result label.

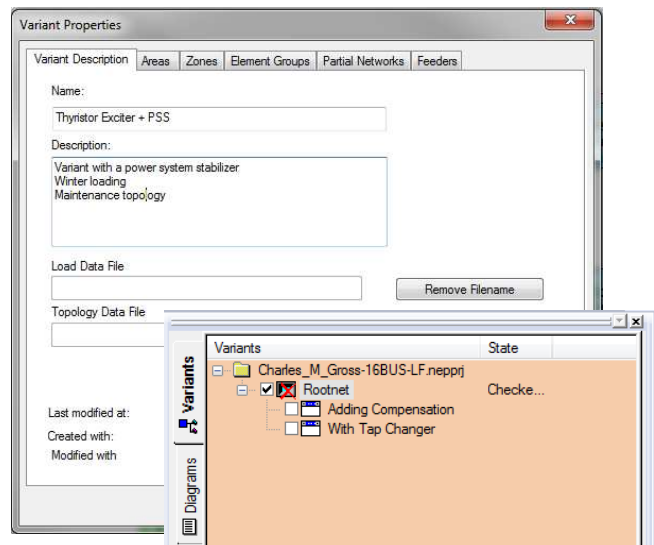

- Results of two variants can be compared in the chart manager.

Multi-Diagram and Multi-Layer-Technique

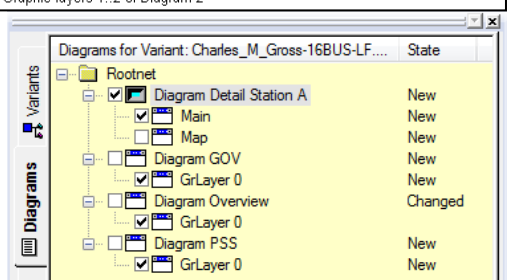
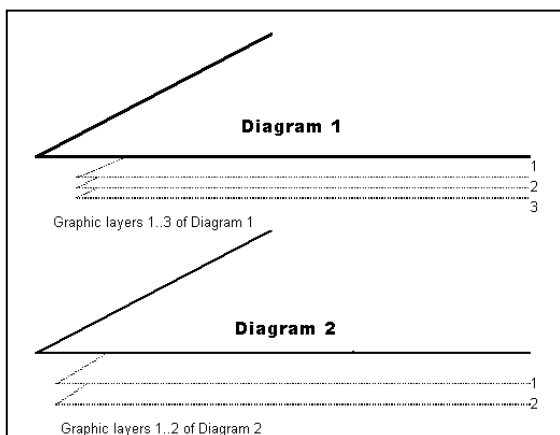

- A network can be entered in several different diagrams, so that the HV network, for instance, is in one diagram, and the MV network in one or more other diagrams.
- Each diagram can have any number of graphic layers. These layers can be colored, locked, hidden or shown.
- Zooming into stations: in the overview diagram, a station is shown as a black box, while in another diagram it is depicted in detail, with all its breakers, protective devices and instruments.
- Topological linkage of elements over more than one diagram.
- All diagrams will be considered for various analysis (e.g. load flow).
- One element can have more than one graphical representation in the same diagram or in different diagrams.
- OLE copy/paste graphic data from and to MS-Word



Auxiliary Graphics

- Auxiliary graphics can be used for documenting the diagram.
- Input of lines, rectangles, ellipses, arcs, ellipse sections, polygons, polylines, any kind of bitmap graphics.
- Input of user text with selectable character set.
- Color for background, foreground, line, outlines and fill patterns is user-selectable.
- Functions available for rendering overlapped symbol elements, rendering, alignment and rotation

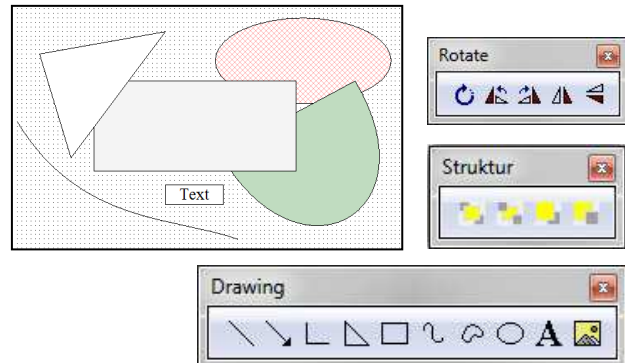

Network Diagram Coloring

- Colors and line types can be freely selected.
- Elements overloaded after a load flow or short-circuit-current analysis are color-highlighted.
- Isolated elements can be highlighted.
- Coloring options to distinguish user-selectable network areas, zones, feeders, voltage levels, earthed or un-supplied networks and galvanic separated networks.
- Differences to the parent variant or the root net can be colored.
- Each element can be colored individually.
- User defined graphic layers can be colored.
- Coloring according to ranges. Many calculated variables can be colored according to their values (e.g. according to element losses or according to voltage drops)
- Results in tables and graphic charts, flow animation, background visualization, gauche, pie charts

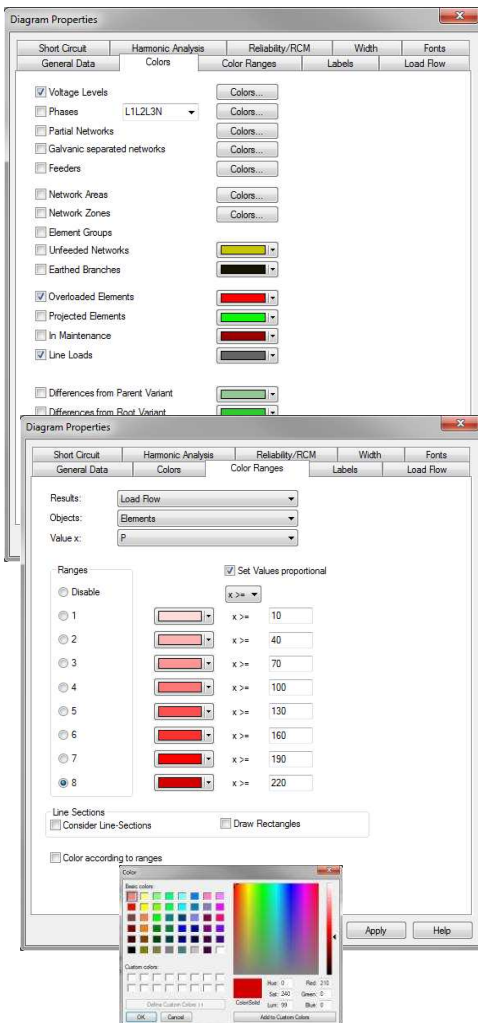



Symbol-Editor

- The user can create and define for each element type and node his own symbols.
- Any number of different symbols per element type or node can be defined.
- All symbols will be displayed while entering the diagram. Just drag and drop the desired symbol to the diagram
- On the diagram the symbols can be flipped, rotated and resized.

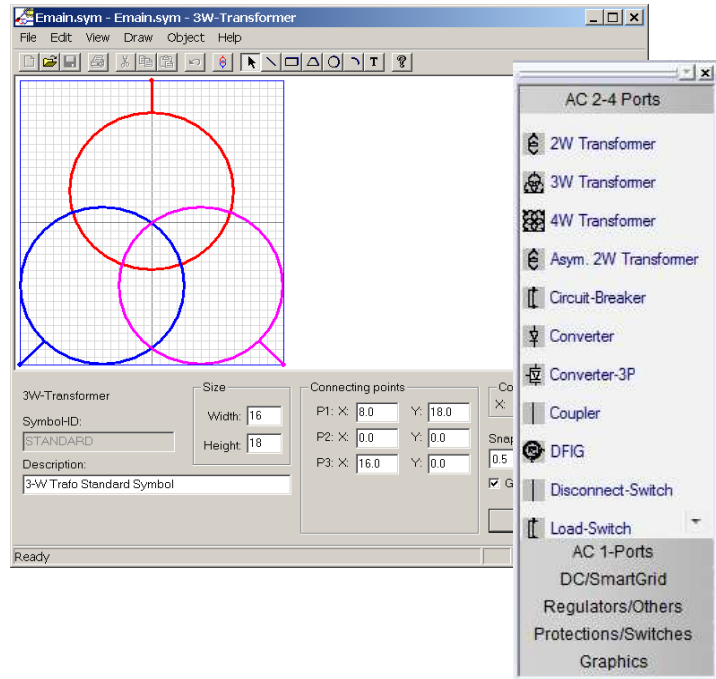

SQL Database Connection

- All element data can be imported and exported to any SQL database (like Oracle, MS-Access, etc.)
- SQL database includes all network equipment (HVDC, FACTS, protection devices, user defined data, etc.).
- The network topology can be stored.
- Graphic of the elements and nodes can be exported and imported.
- All data of all libraries can be imported and exported.
- Can be used as interface to existing GIS and NIS or DMS/SCADA systems.
- Very flexible storing and import features, like full import or only updating, storing only variant differences, network zones or areas, voltage levels, etc.
- Handles very large networks
- Partial reading of data fields (e.g. read only the line length but do not read the R and X values)

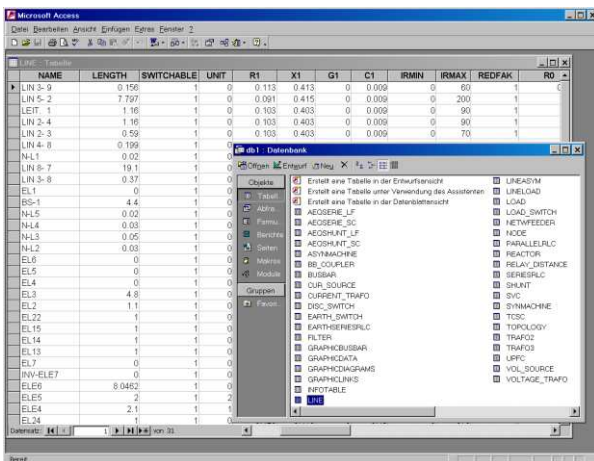

Graphical User Interface and Data Management

Application: Transmission – Distribution – Industrial - Generation



Library Manager

- The comprehensive library manager is fully integrated.
- NEPLAN offers an extensive element library for lines, synchronous and asynchronous machines, transformers, harmonic current sources and motor characteristics.
- The user can create complementary libraries.
- While entering network data the data in the library can be accessed. Further more the data entered in the network, can be exported to the library.
- All network data can be updated with changed library data.
- The data can be entered through excel like table sheets.
- Import/export to MS-Excel with drag and drop.
- Import/export to any SQL database. Update functionality from/ to database is provided.
- Part of diagrams with all technical data can be stored in the library (e.g. used for IEEE control circuits).

ID	Type	Description	Capacitance	Resistance	Inductance	Capacitance	Resistance	Inductance	Capacitance	Resistance	Inductance	Unit of Length	Initial Value	Initial Value	Initial Value	Red. Factor	Unit	
1	1	NVY 40 1.5	12.1	0.115	0	40.4	0.433	0	0	0	0	km	0	0	26	0	1	0
2	2	NVY 40 2.5	2.261	0.111	0	28.121	0.441	0	0	0	0	km	0	0	24	0	1	0
3	3	NVY 40 4	4.36	0.107	0	18.24	0.426	0	0	0	0	km	0	0	44	0	1	0
4	4	NVY 40 6	5.53	0.1	0	12.32	0.403	0	0	0	0	km	0	0	56	0	1	0

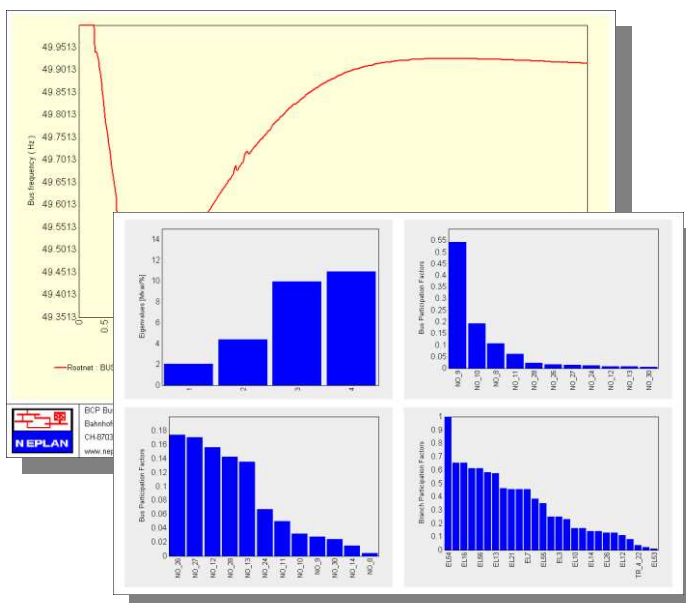

Chart Manager

- The chart manager allows to display the results in different charts (e.g. line, bar, etc.).
- Any number of sub charts can be displayed in one chart.
- A user defined logo (as bitmap) can be added to the header for documentation purposes
- Results from different variants can be compared and displayed in the same chart.
- Export the chart to *.JPG file for any internet browser.
- Copy/paste to the clipboard for documentation (e.g. MS-Words).

Data storing and Interfaces

NEPLAN stores all the network data, such as single line diagram, protection devices, controllers, calculation parameters and results in an internal database in order to handle in an easier and faster way the data.

NEVERTHELESS represents NEPLAN a very open system. All NEPLAN data are accessible from external system. Principally there several ways to transfer data from or to NEPLAN:

- NEPLAN Programming Library (NPL)
- ASCII files (Excel)
- GIS/SCADA interface
- SQL database

NPL is a C/C++ API library, which includes functions to access NEPLAN data and calculation algorithms through a C/C++ user written program. More information could be found in a separate document.

The ASCII files allows to import/export all the

- electrical parameters of the primary elements, like lines, transformers, generators, motors, etc.
- load and measurement data as well as pre-defined load profiles
- protection device types and settings
- Harmonic currents and voltages
- Control circuit data (function blocks)

The GIS/SCADA interface is supported by many GIS manufacturers and is an ASCII file, which includes only the most essential information, such as graphic information, interconnection of elements, state of switches, type of elements and the line length. The electrical data are taken from the NEPLAN library.

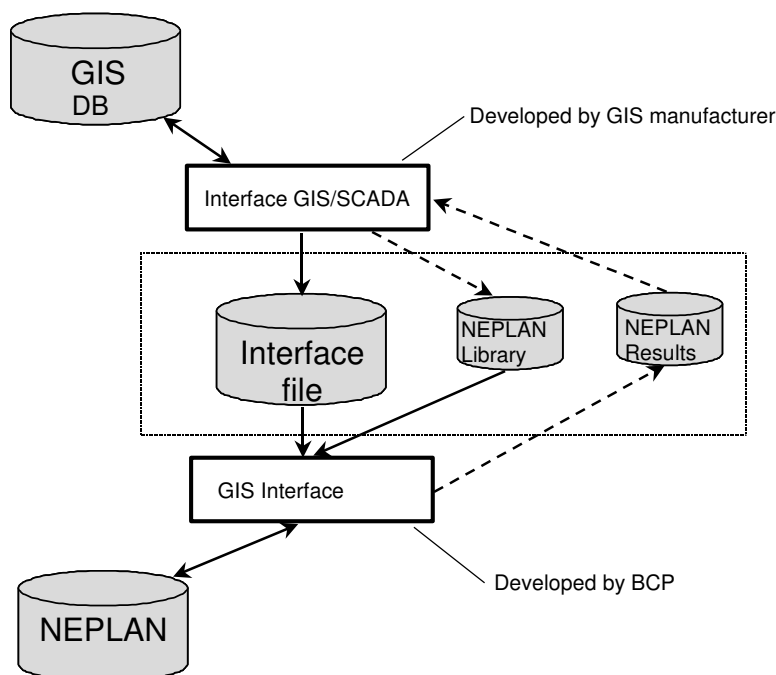

Graphical User Interface and Data Management

Application: Transmission – Distribution – Industrial - Generation

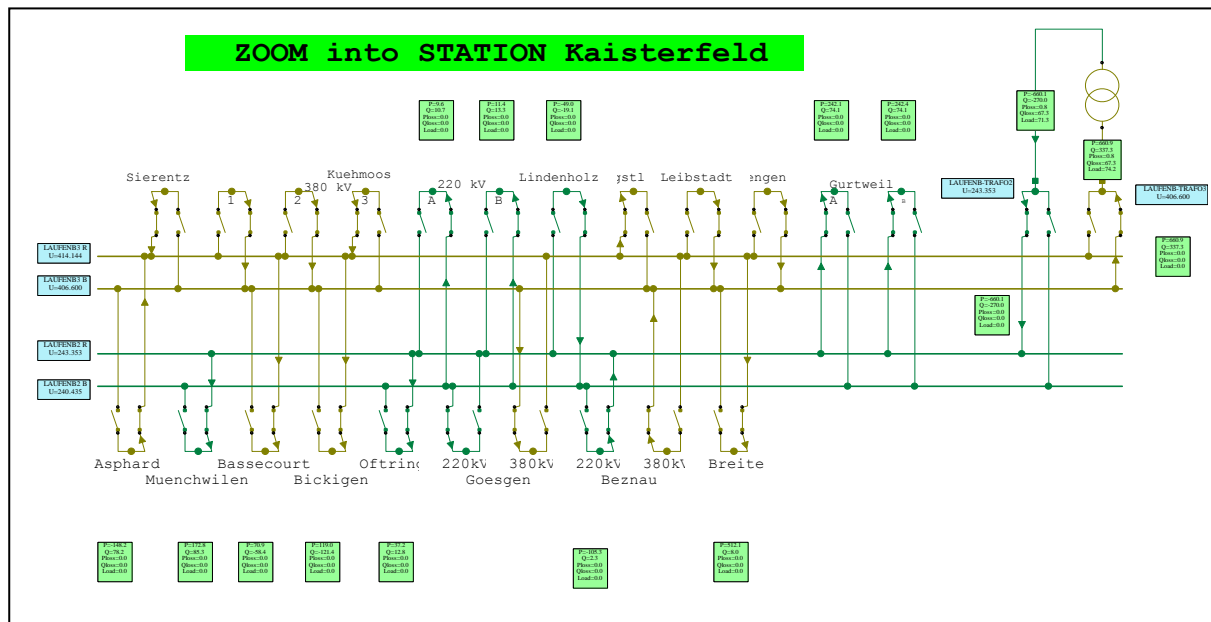
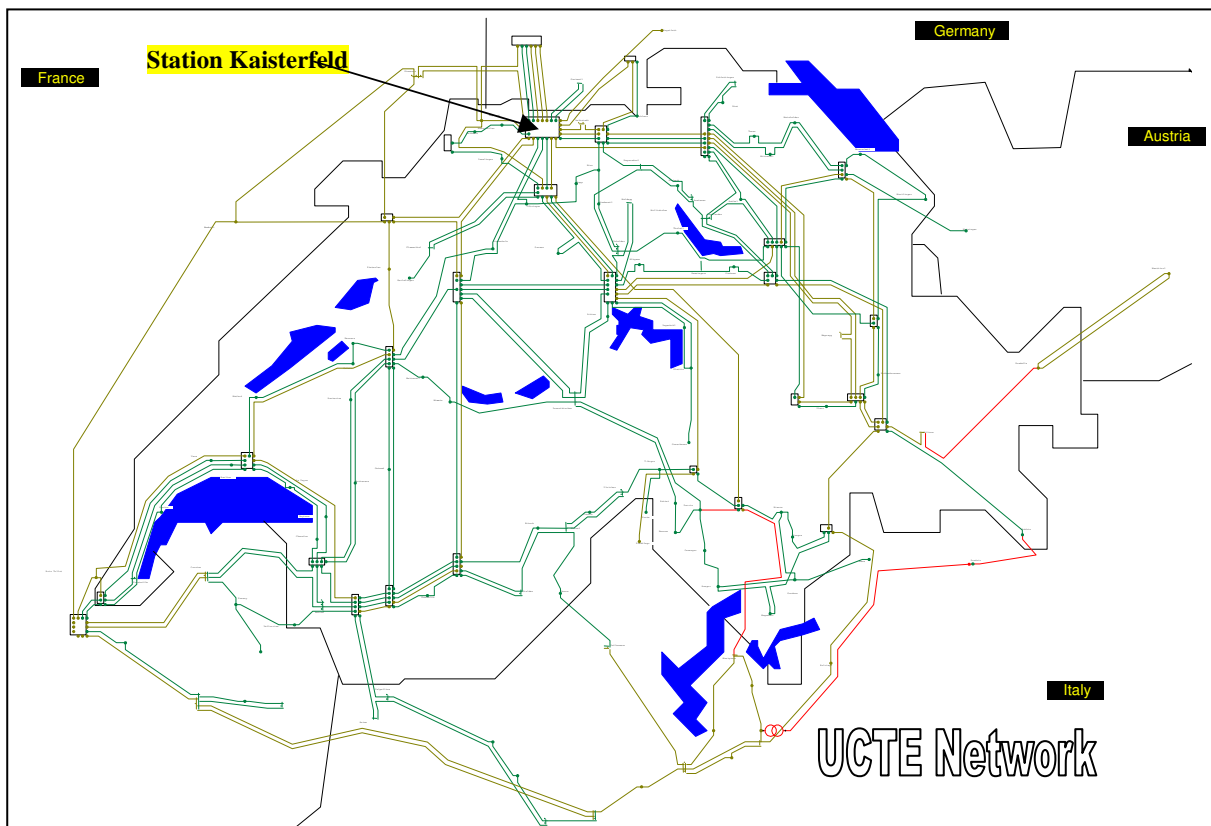

Graphical User Interface and Data Management

Application: Transmission – Distribution – Industrial - Generation

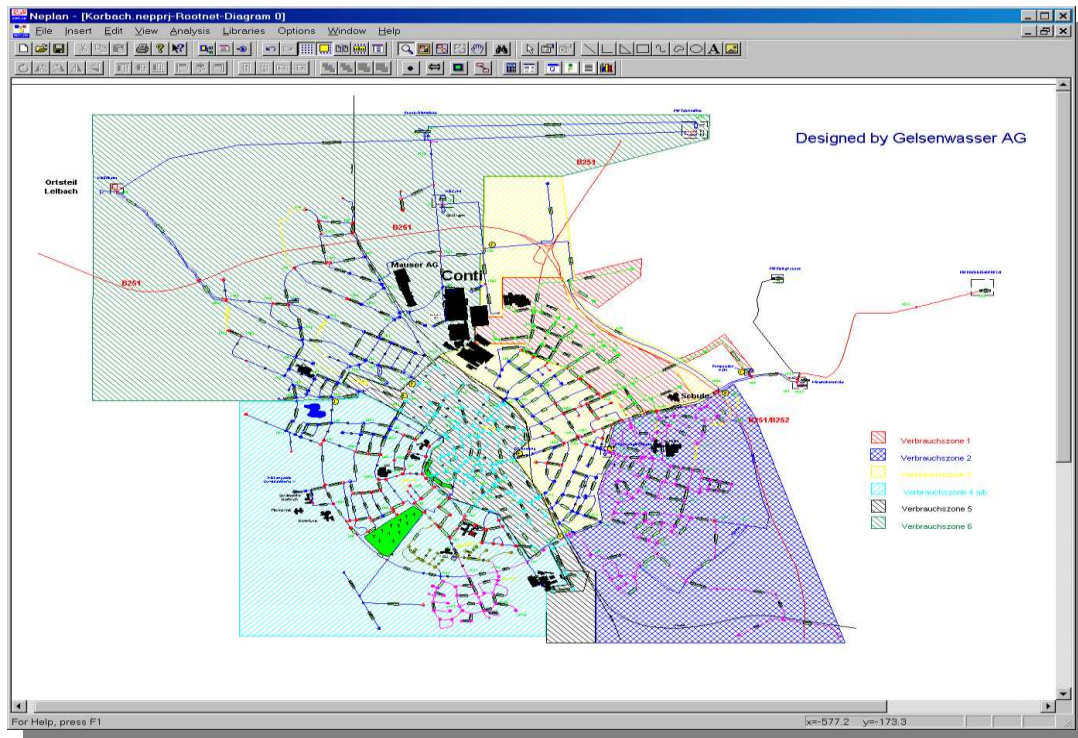
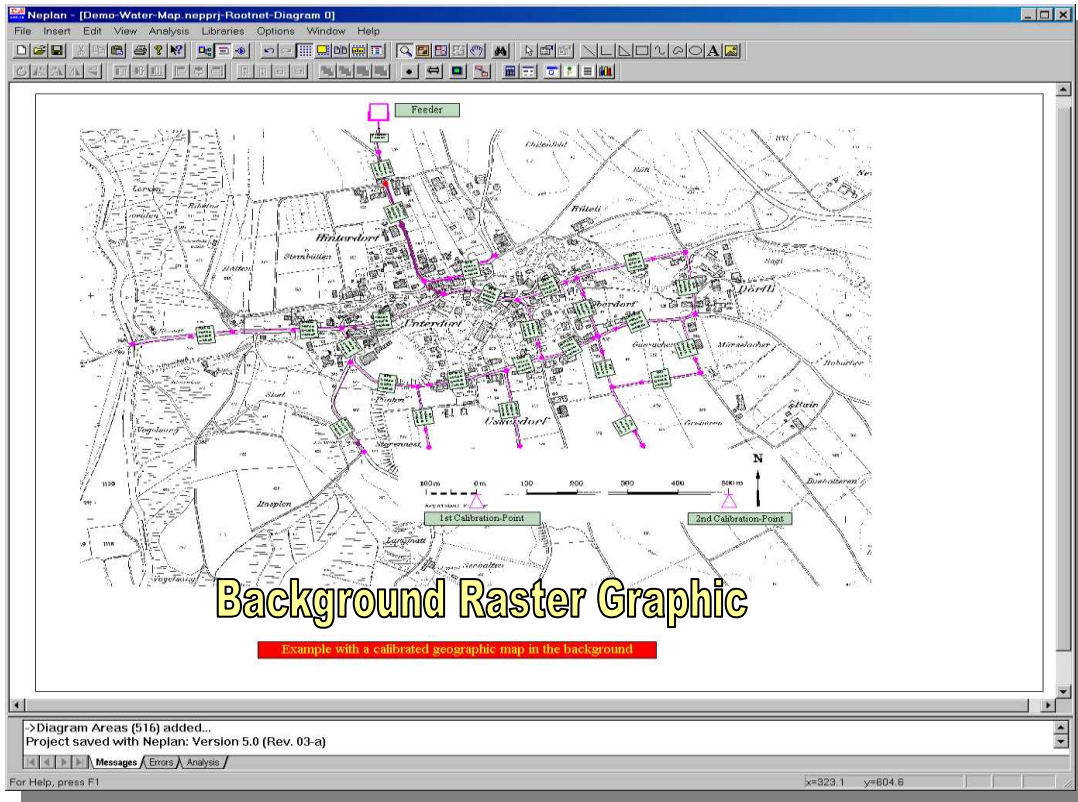



The power system analysis software NEPLAN consists of several modules, which can be bought individually. The modules can be grouped as follows:

Base Modules

- Load Flow/Contingency Analysis
- Short Circuit Analysis
- Harmonic Analysis
- Motor Starting Analysis
- Line Parameter Calculation
- Network Reduction
- Investment Analysis (present value)
- Dynamic Simulator: RMS-Simulation
- Over current Protection
- Distance Protection
- Reliability Analysis
- NPL Programming Library (C/C++)
- Interfaces GIS/SCADA (SQL, ASCII)

Transmission Modules

- Base Modules
- N-1 constrained Optimal Power Flow
- Available Transfer Capability Analysis (ATC)
- Dynamic Simulator: RMS, EMT, Phasor dynamics
- Voltage Stability
- Small signal Stability
- Day-Ahead Congestion Forecast (DACF)
- Asset Management (RCM)
- Grounding System Analysis

Industrial Modules

- Base Modules
- Cable sizing
- Arc Flash Calculation
- Grounding System Analysis

Distribution Modules

- Base Modules
- Load Forecast / Load profiles
- Optimization of Distribution Network
- Assessment of network disturbances
- Optimal Feeder Reinforcement
- Optimal Capacitor Placement
- Phase Swapping
- Optimal Network Restoration Strategy
- Cable thermal analysis
- Low-voltage calculation
- Fault Finding
- Asset Management (RCM)

NEPLAN Toolbox for Research

- All Modules
- NPL Programming Library (C/C++)
- Matlab/Simulink Interface

Some of the modules are explained below. Please ask for more information or visit our Homepage www.neplan.ch.

Load Flow Analysis

Application: Transmission – Distribution – Industrial - Generation



General Characteristics

- Computation methods: Current Iteration, Newton Raphson, Extended Newton Raphson, Voltage Drop (per-phase), DC load flow
- 3-, 2- and 1-phase AC and DC systems for meshed, looped and radial networks from HV to LV
- Disperse generation models (wind power, photo voltaic, small hydro, geothermic, etc.)
- User-defined modeling with NEPLAN® C/C++ API.
- Voltage and flow control with phase-shifting transformers.
- HVDC, PWM and FACTS devices, like SVC, STATCOM, TCSC, UPFC
- Node types: slack, PQ, PV, PC, SC, PI, IC with intuitive assignment. More than one slack node possible.
- Power interchange between area / zones (area interchange control) and distributed slack node
- Predefined and user defined scaling factors for fast load and generation variations
- Measurement data import and load balancing
- Calculation of loss sensitivities (PDTF-factors)
- Powerful convergence control with initialization file input / output
- Limit check and appropriate automatic conversion of the node type.

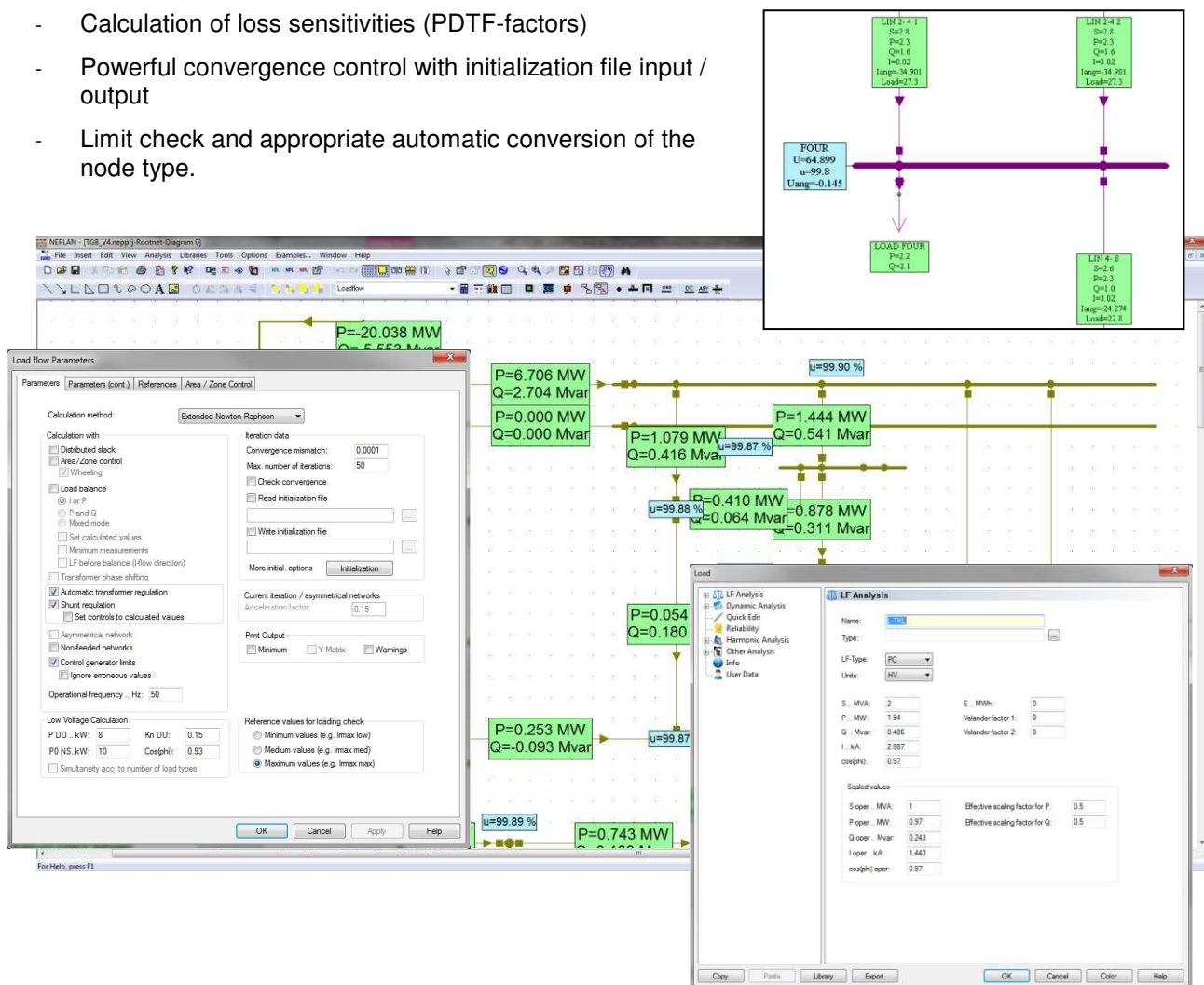

Load Flow Analysis

Application: Transmission – Distribution – Industrial - Generation



Results

- Automatic display of results.
- 'Move' and 'Delete' function for result boxes.
- Self-defined result output: the user can select items, units, font, precision, placement.
- Overloaded elements or nodes with voltages outside predefined limits are highlighted.
- Line thickness corresponds to element loading.
- Results can be saved in a text file (ASCII).
- Table output: for the whole network, individually for each area / zone. Listing of power flows between area/zones, overloaded elements, sorting function, selective output.
- Table interface with MS-Excel.

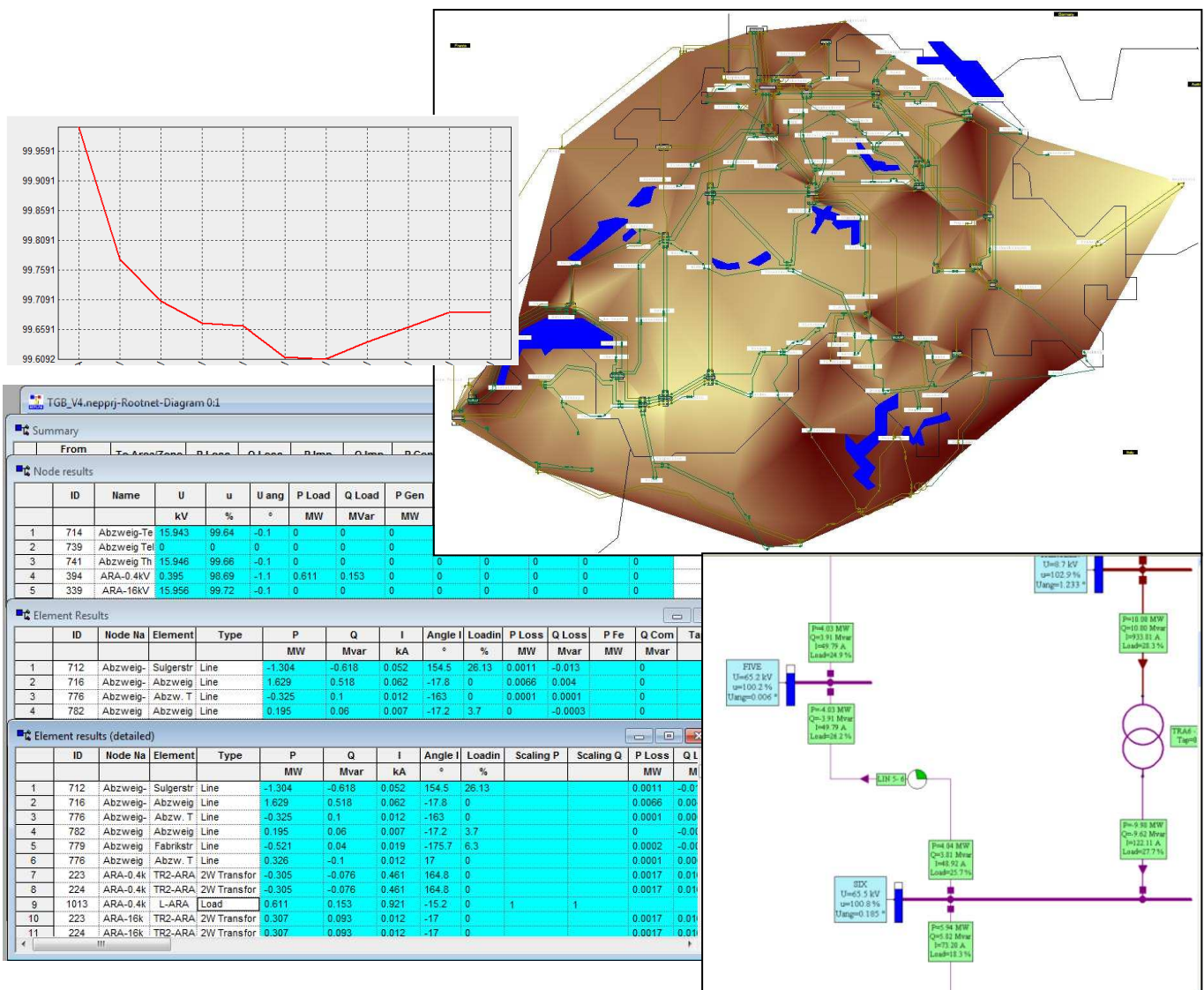

Short Circuit Analysis

Application: Transmission – Distribution – Industrial - Generation



General Characteristics

- Standards IEC 60909, ANSI/IEEE C37.10/C37.13
- IEC 61363-1 for off-shore/ship plants, IEC 61660 for DC networks
- 3-phase, 2-phase and 1-phase AC system or DC networks
- Superposition method with consideration of prefault voltages from a load flow.
- Computation of single-, two- (with and without earth connection) and three-phase faults.
- Option for computing user-defined fault types (e.g. double earth fault, fault between two voltage levels).
- Option for computing line faults (fault location on line user-selectable).
- Computable fault current types: initial symmetrical short-circuit current and power, peak, breaking, steady state, thermal and asymmetrical breaking current, plus DC component.
- Computation of minimum/maximum short-circuit current.
- Accurate model for transformer earthing connection.
- Petersen coil tuning in resonance earthed networks
- Current limiting due to circuit breakers and MOV.

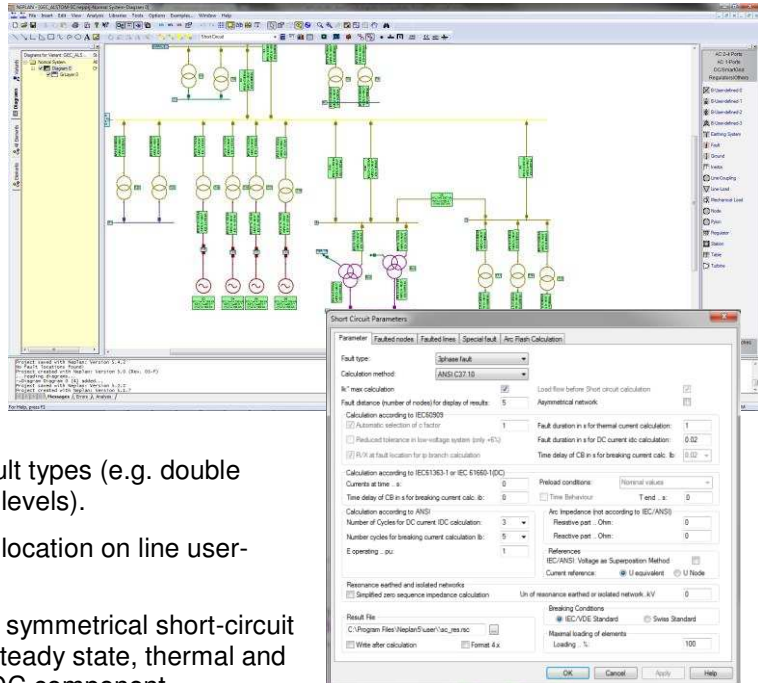

Line Coupling

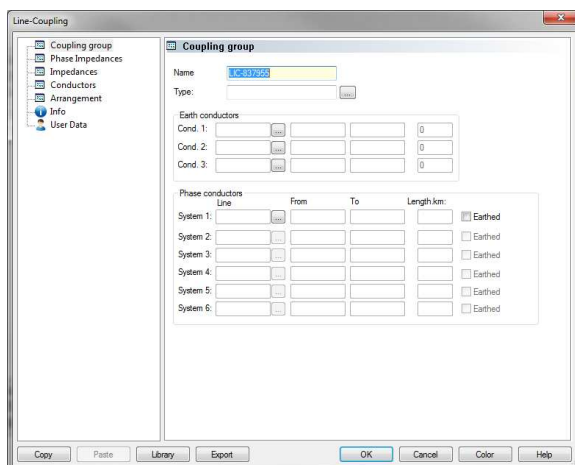

- Mutual impedances and capacitances in the positive and negative-sequence systems are allowed for in short-circuit current computation.
- Circuit and coupling parameters of the overhead lines are computed from the conductor configuration.
- Overhead lines with up to 6 3-phase systems and 3 earth wires can be computed (earthing of 3-phase systems considered).
- Unrestricted number of overhead lines can be entered.
- Parameters and conductor configuration are saved in an SQL database.

Short Circuit Analysis

Application: Transmission – Distribution – Industrial - Generation



Results

- Automatic display of results.
- Move and delete function for result boxes.
- Self-defined result output in regard to units, formats and fault current types.
- Results can be inserted either at the beginning and/or end node, or also in the element's center.
- In the event of a short-circuit, all overloaded pieces of equipment (current transformers, voltage transformers, circuit-breakers, etc.) are highlighted.
- Results can be saved in a result file (ASCII file) and in an SQL database.
- Result lists can be saved in text files.
- List output: sorted by voltage levels. Short-circuit impedance and all computable fault currents are output as phase values or as symmetrical components.

The screenshot displays the NEPLAN software interface with three data tables and a circuit diagram. The circuit diagram shows a three-phase system with a fault at node 6, and callouts for fault currents at nodes 6, 3, and G3.

ID	Fault location	To Node	Distance from	Element name	Type	Un	U L-E (RST)	AU L-E (RST)	Ik* (RST)	Aik*(RST)	Fault Type	Method
	From		fault			kV	kV	°	kA	°		
1	137536	BARRAJE	0	Faulted		132.00	76.21	180.00	8.271	-90.00	3phase	ANSI

ID	Fault location	Un	Ik*(RST)	Aik*(RST)	Fault Type	Method	Maximum	Network Type	Number of cycles	SC duration	Description
		kV	kA	°						cycles	
1	137536	BARRAJE D	132.000	8.271	-90.00	3phase fa	ANSI C37		GEN NEAR: 5.00	3.000	

ID	Name	Faulted	Un	U L-E (RST)	AU L-E (RST)	U L-L (RST)	AU L-L (RST)	U (012)	AU (012)	U0	AU0
			kV	kV	°	kV	°	kV	°	kV	°
1	137536	BARRAJE D	132.000	76.210	180.00	132.000	330.00	76.210	180.00	0.000	-90.00
2	137535	BARRAJE C	132.000	76.210	180.00	132.000	330.00	76.210	180.00	0.000	-90.00
3	137534	BARRAJE A	132.000	76.210	180.00	132.000	330.00	76.210	180.00	0.000	-90.00
4	137544	E	132.000	48.404	180.00	83.838	330.00	48.404	180.00	0.000	-90.00
5	137548	B	132.000	76.210	180.00	132.000	330.00	76.210	180.00	0.000	-90.00
6	137545	F	132.000	65.088	180.00	112.735	330.00	65.088	180.00	0.000	-90.00
7	137540	T17	11.800	2.917	180.00	5.052	330.00	2.917	180.00	0.000	-90.00
8	137539	T16	11.800	2.917	180.00	5.052	330.00	2.917	180.00	0.000	-90.00
9	137542	T15	11.800	2.917	180.00	5.052	330.00	2.917	180.00	0.000	-90.00
10	137549	B1	33.000	19.053	180.00	33.000	330.00	19.053	180.00	0.000	-90.00
11	137547	C1	11.000	6.351	180.00	11.000	330.00	6.351	180.00	0.000	-90.00
12	137546	F1	33.000	16.272	180.00	28.184	330.00	16.272	180.00	0.000	-90.00
13	137543	D1	33.000	19.053	180.00	33.000	330.00	19.053	180.00	0.000	-90.00
14	137541	T18	11.800	2.917	180.00	5.052	330.00	2.917	180.00	0.000	-90.00
15	137550	E1	275.000	17.730	180.00	30.710	330.00	17.730	180.00	0.000	-90.00
16	137551	TER. T9	11.000	3.480	180.00	6.027	330.00	3.480	180.00	0.000	-90.00
17	137552	TERC. T10	11.000	3.480	180.00	6.027	330.00	3.480	180.00	0.000	-90.00

Node 6 Data:
 $I_k''(L1) = 37.563 \text{ kA}$
 $i_p(L1) = 98.143 \text{ kA}$
 $I_b(L1) = 34.003 \text{ kA}$
 $I_k(L1) = 34.356 \text{ kA}$

Node 3 Data:
 $I_k''(L1) = 14.265 \text{ kA}$
 $i_p(L1) = 37.272 \text{ kA}$
 $I_k(L1) = 14.265 \text{ kA}$

Node G3 Data:
 $I_k''(L1) = 5.828 \text{ kA}$
 $i_p(L1) = 15.227 \text{ kA}$
 $I_b(L1) = 3.754 \text{ kA}$
 $I_k(L1) = 5.828 \text{ kA}$

Motor Starting Analysis

Application: Distribution – Industrial - Generation



Motor Starting Computation

- Simulation of motor start-up in unlimited networks.
- Simultaneous or time-delayed start-up for any desired number of motors.
- Identification of motor parameters using the least square method from input values for torque, current and $\cos(\phi)$ in function of the slip.
- Different motor models, depending on the motor data entered.
- Saturation and eddy-current losses in the motor allowed for (linear or point-by-point).
- Libraries for standard motor data, plus additional libraries for $M_e(s)$, $I(s)$ and $\cos(j(s))$ are available (can be extended by the user).
- Operating point computation for all non-starting motors in accordance with their load characteristics (Newton-Raphson).
- Automatic tap changing transformers are allowed for after a user-defined time-delay.
- Load torque entered as a characteristic or as a linear or quadratic load torque curve.
- Libraries for load torques are available (can be extended by the user).
- Start-up devices are allowed for, such as star-delta starter, series resistor, transformer, soft starter, etc.

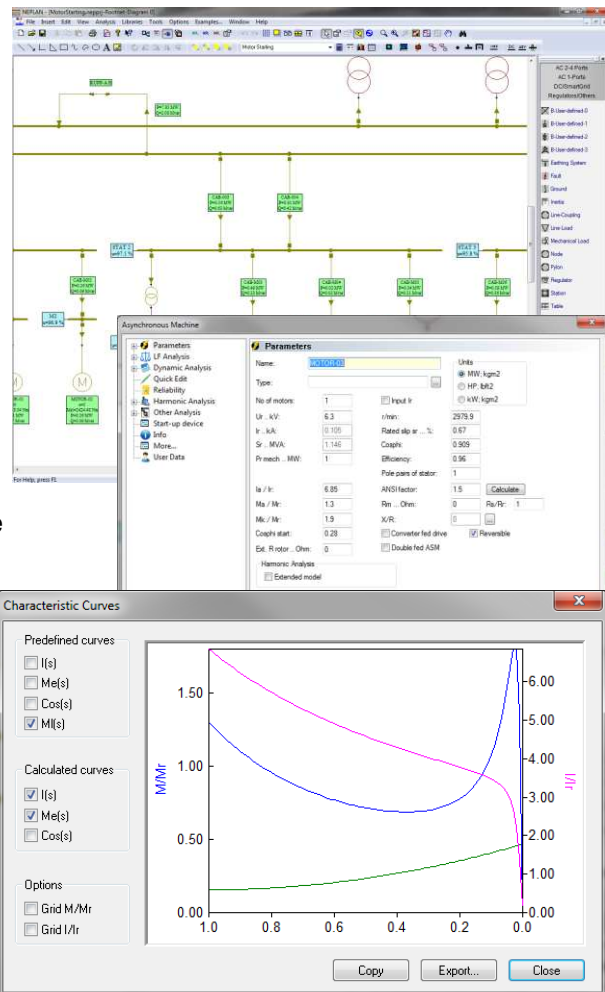

Voltage Drop

- Computation of voltage drop to the moment $t = 0$.
- Reduced data entry for motors and computation parameters.
- Non-starting motors can be simulated by a user-defined M/PQ (constant power) or shunt.
- Overloaded elements, measuring instruments and protective devices or nodes with voltages outside a defined range are highlighted.
- Results of the voltage drop computation are displayed in the single line diagram.
- The motor data entered and the motor parameters computed can be accessed by clicking on the motor concerned in the single line diagram.

Motor Starting Analysis

Application: Distribution – Industrial - Generation



Results

- Computation of voltage $U(t)$ at predefined nodes.
- Computation $I(t)$, $P(t)$, $Q(t)$ for each predefined element.
- Computation of motor current I , load torque M , electromagnetic torque M_e , active power P and reactive power Q as functions of time, or of the slip for starting-up and non-starting-up motors.
- Graphical output of the characteristic curves and time characteristics, with automatic scaling of the axes.
- Dimensioning and colors can be altered.
- Result lists can be saved in text files.
- Results can be saved in result files for evaluation by means of spreadsheet programs (such as MS-Excel).

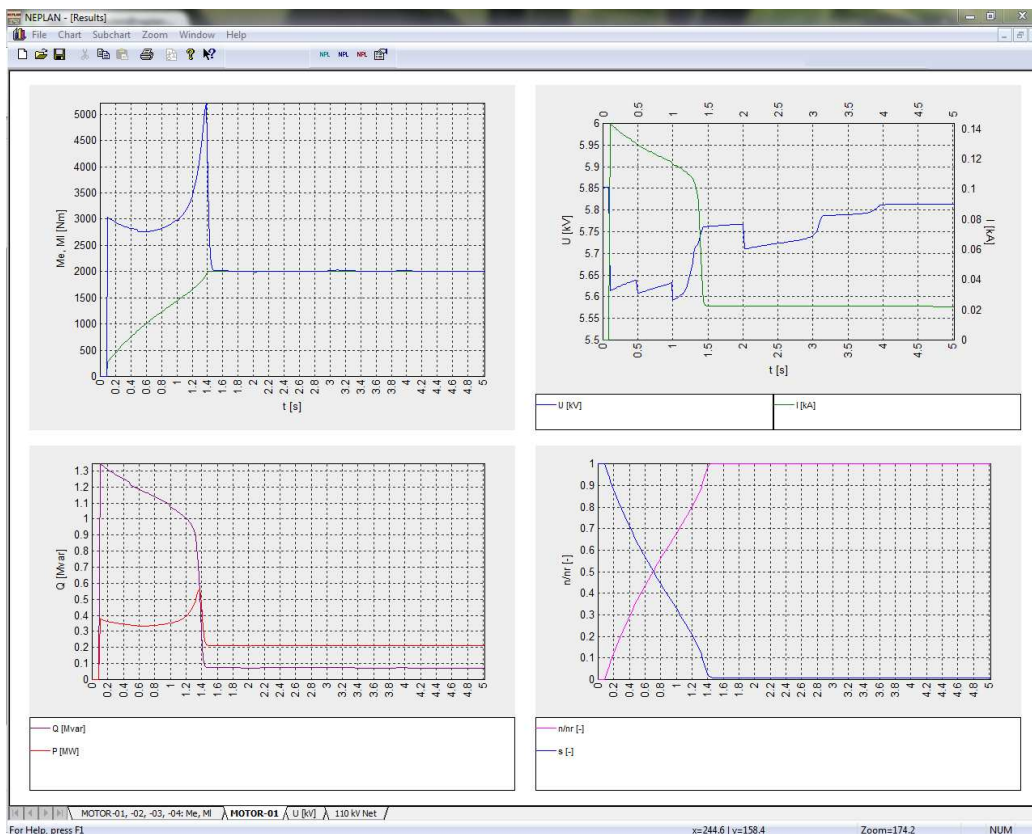
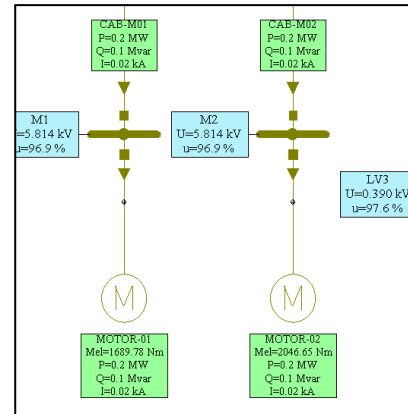

General Characteristics

- 3-phase, 2-phase, 1-phase AC systems.
- Planning of ripple control systems, dimensioning of compensators (SVC) and harmonic filters, determination of network impedance for sub-synchronous resonance or filter design.
- Frequency response of meshed networks.
- U-I and I-U sensitivity for each frequency.
- Distributed parameter line model applied.
- Computation of network impedance and harmonic level for each frequency and for each node.
- Frequency-dependence of elements is considered. Libraries available.
- Automatic frequency step length control during impedance computation to detect resonances.
- Calculation in the positive component system (symmetrical) or in the phase system
- Calculation of self- and mutual line impedances in function of the frequency
- Harmonic load flow (P, Q, I, U, losses)
- Results in frequency or time domain.

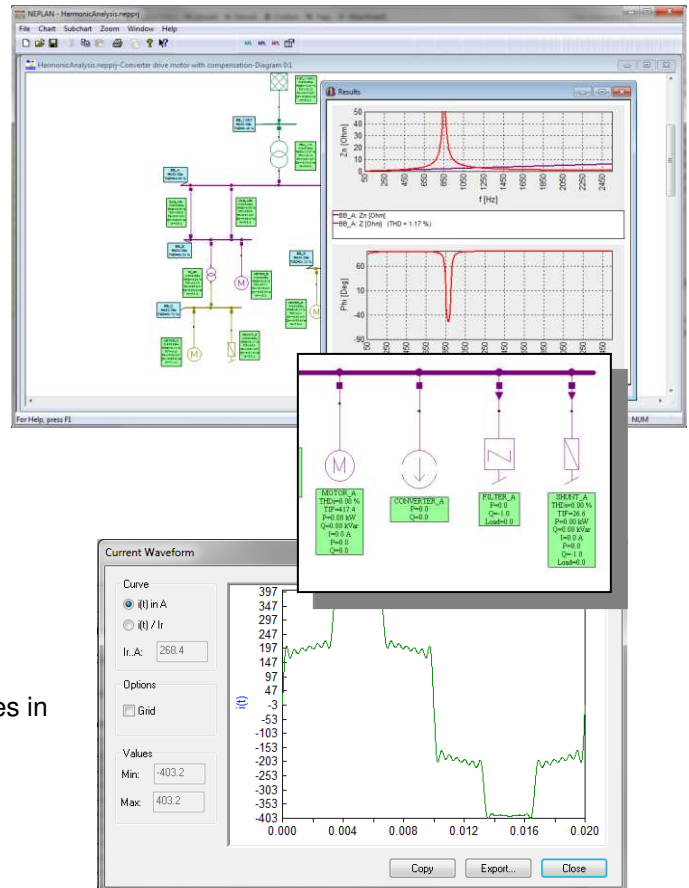

Harmonic Levels

- Current and voltage computation at all frequencies and at all predefined nodes and elements.
- Computation of r.m.s. values for harmonic voltages and currents with fundamental harmonic voltage or current taken from the Load flow (optional).
- Computation of total harmonic voltage factor in conformity with DIN/IEC and distortion factor in accordance with IEEE.
- Computation of telephone parameters (TIF, IT, KVT) or transformer k-factor.
- Comparison of computed harmonic levels with the limit values laid down in any standards desired.
- List output of ripple control currents and voltages at any desired frequencies and at each node and each element.
- Automatic entry of results in the single line diagram.
- Harmonic sum calculation: vectorial, geometric, arithmetic, acc. to IEC 1000-2-6

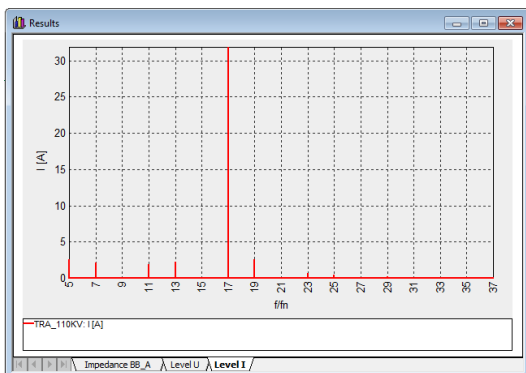

Harmonic Analysis

Application: Transmission – Distribution – Industrial



Harmonic source

- Harmonic sources (current and voltage sources) are entered directly in the single line diagram. Libraries available
- Harmonic sources can be assigned directly to loads or any power electronic elements, such as Converter, SVC, PWM, etc.
- Unlimited number of harmonic sources (current/voltage) can be computed with each harmonic.
- Any harmonic can be handled, e.g. inter-harmonics due to saturation effects.

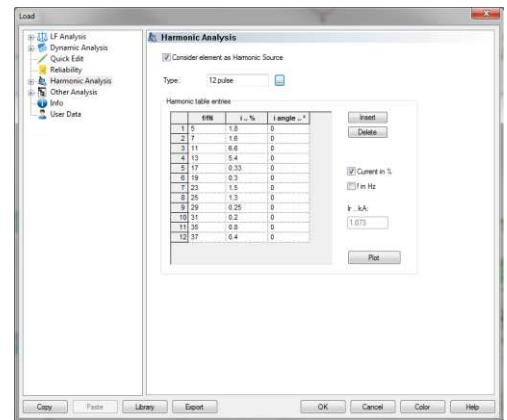

Filter Dimensioning

- Filter elements are transferred directly into the single line diagram.
- Filter elements: filters (normal, HP, C-filter), series RLC-circuits with or without earth connection, ripple control traps.
- Filters are dimensioned directly by the program.
- Filter data are listed or saved in a text file.
- Result lists can be saved in text files.
- Results can be saved in result files for evaluation by means of spreadsheet programs (like MS-Excel).

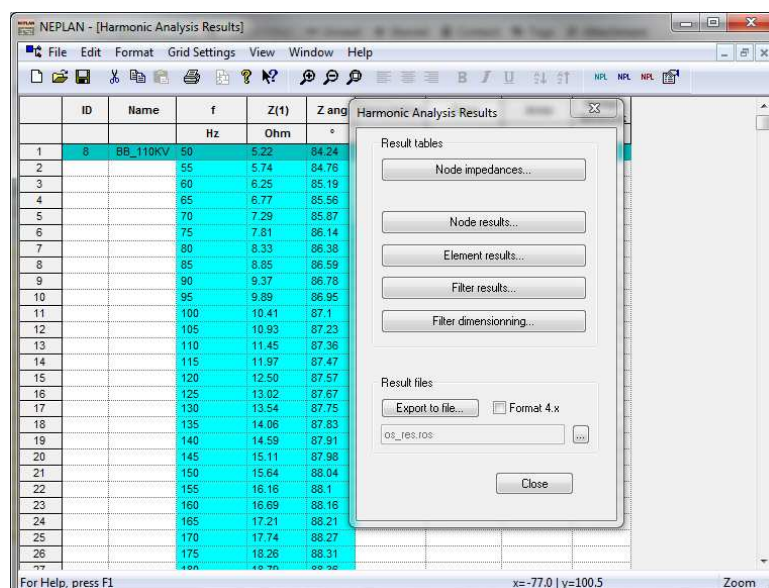
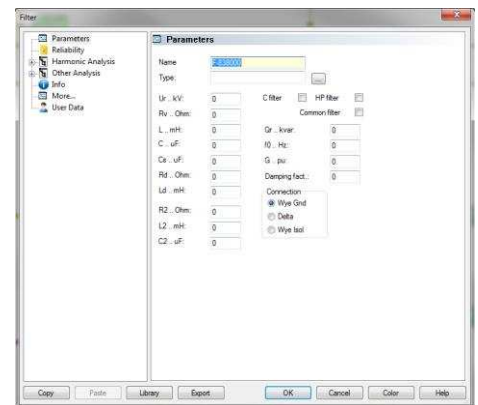

Selectivity Analysis

Application: Distribution – Industrial - Generation



General Characteristics

- All types of protective devices with a current-time characteristic can be entered: fuses, circuit-breakers, definite-time and inverse-time over-current relays, electronic relays.
- Several protective functions can be assigned to each protective device: non-directional or directional over-current and earth-fault protection).
- Exact modeling of setting ranges
- Extensive libraries with protective devices from a variety of manufacturers are available, and can be extended at will.
- Option for entering user-defined characteristics for simulating motor start-ups or thermal capability of conductors, transformers, etc.
- Characteristic can be shifted using a k-factor (inverse-time relay).
- Entry options for characteristics: point-by-point or formula in conformity with IEC or IEEE/ANSI.
- Simulation of fault clearing procedure in meshed networks, involves also distance protection.

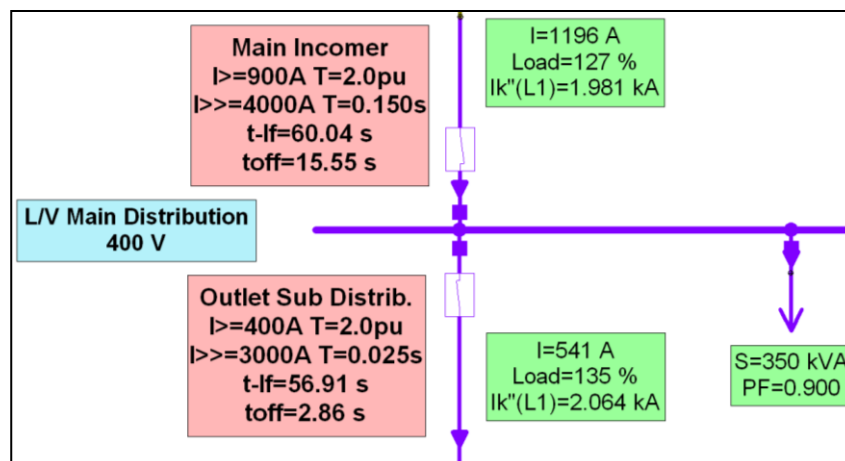
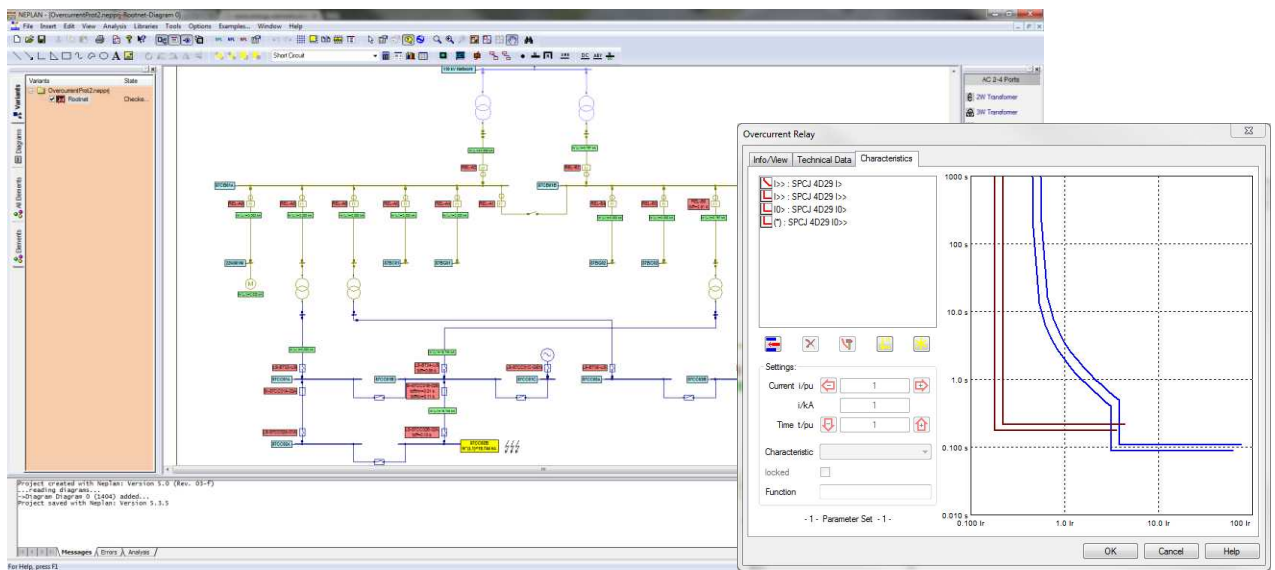

Selectivity Diagram

- Protection device and current transformers are positioned in the network plan graphically.
- Automatic generation of selectivity diagrams based on s/c calculation
- Unrestricted number of characteristics can be incorporated in one diagram.
- Changing the relay settings directly in the selectivity diagram
- Unrestricted number of diagrams can be processed simultaneously.
- Selectivity analysis over more than one voltage level and independently of the network type and size involved.
- Two reference voltages for diagrams can be user-defined.
- Individualized coloring of the characteristics.
- No limit on number of diagrams and protective numbers for management.
- Export of complete diagram to Word etc. by clipboard or emf-files

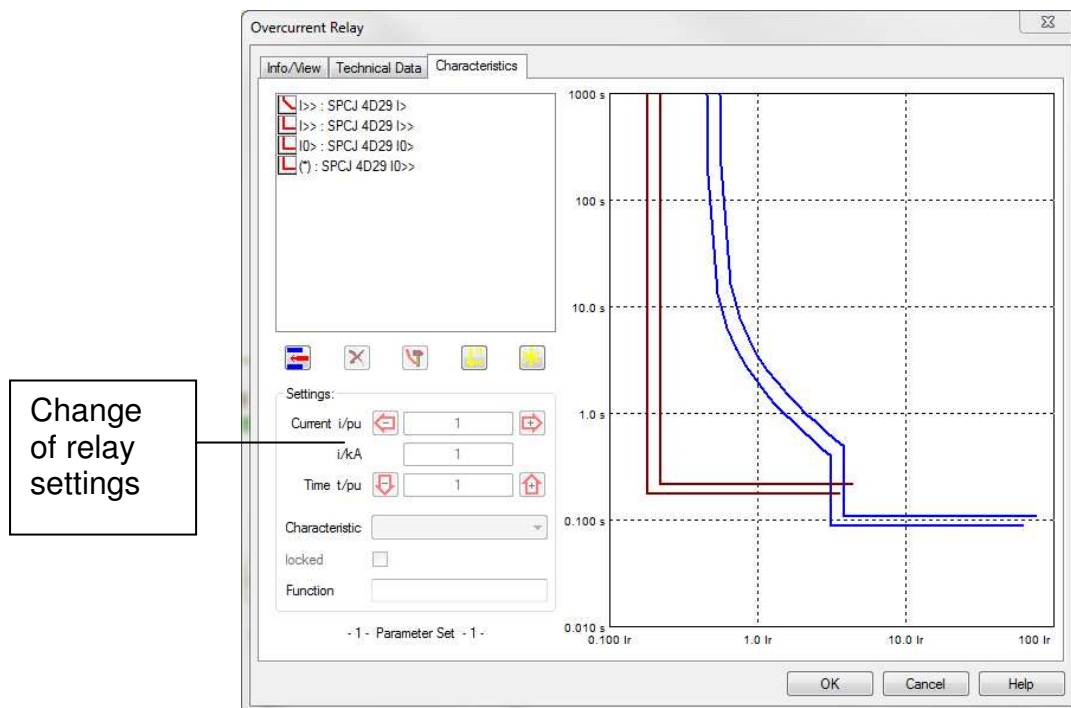

Transferring Current Values

- Direct connection from short-circuit current and load flow module for transferring the currents.
- Unrestricted number of currents can be transferred into one diagram.
- Import/export functions.

Protection Libraries

NEPLAN offers extensive libraries with most used relays-, circuit breaker - and fuse-types. The libraries are constantly updated and extended. It will be handed out for free at the moment of a NEPLAN software purchase or can be downloaded anytime from the Internet by users with a valid maintenance contract.

Distance Protection

Application: Transmission – Distribution



- All types of distance protection relays (irrespective of the manufacturer) can be entered.
- Relays up to 4 impedance zones, 1 over reach zone, 1 backward zone and 1 auto-reclosure zone for line-line and line-earth faults can be defined.
- Start-up characteristics: Over current, angle dependent under impedance, R/X-characteristic, directional/bi-directional end time.
- Processes analog and binary signals and sends out binary signals during dynamic simulation. Binary signals can be: Blocking, Enable, Intertripping, Range Extension, External Starting, Auto-reclosure Blocking, etc, e.g. POTT (Permissive over-reach transfer tripping) and PUTT (Permissive under-reach transfer tripping) can be simulated.
- Interaction between distance protection relay with any other relay type can be defined for dynamic simulation.
- Relay can be modeled within Matlab/Simulink or with NEPLAN function blocks for dynamic simulation.
- Input of any R/X-Characteristic: MHO, Circle, Polygone, Lens, etc. or defined by functions
- Modules for over current, power swing, pole slip.
- Interface to relay test devices. Import/Export of RIO-Format (Relay Interface by Omicron).
- Simulation of fault clearing procedure in meshed networks based on the short circuit module. It involves also over current protection.

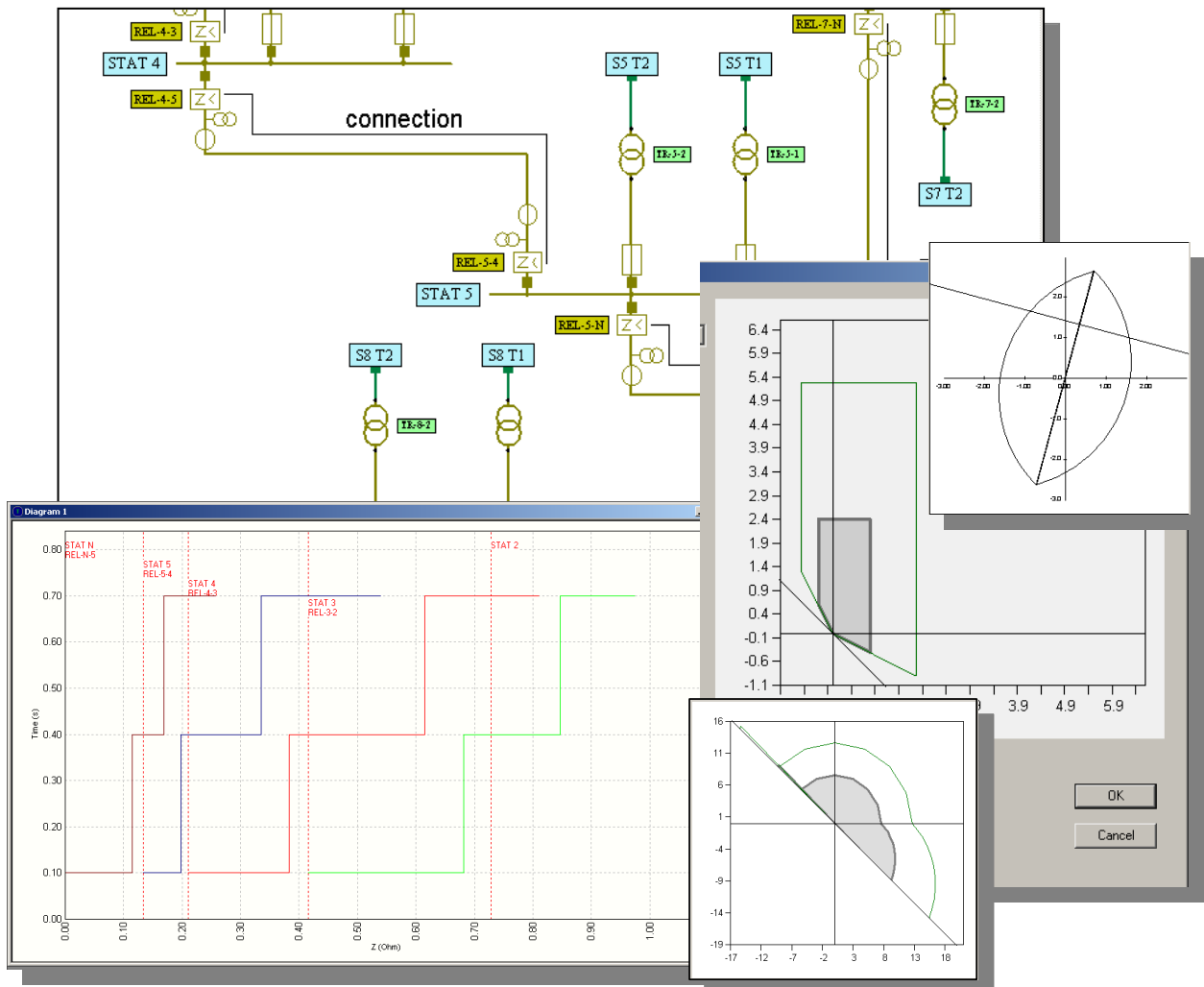

Distance Protection

Application: Transmission – Distribution



- Automatic setting of the relays considering several methodologies (selectable).
- Mutual impedances and capacitances of the positive and zero sequence systems as well as the loading state of the network and infeeds are considered for calculating network impedances.
- Impedance/Reactance of the positive sequence system or the loop impedances are calculated for any short circuit type. Compensation factors due to zero sequence system impedance and mutual coupling are considered in calculating the loop impedances.
- Automatic and user-defined creation of selective tripping schedule.
- Tripping time will be displayed in the single line diagram and in tables after a short circuit calculation.
- All fault types, plus sliding faults of the short circuit module are allowed for.
- Fault location finding. Fault location will be displayed in the single line diagram or listed according to the previously measured impedance value. Tolerance will be considered.
- Interactive change of relay setting parameters and characteristics.

- Display of all calculated impedances with the relay characteristics
- Impedances can be entered/displayed in primary or secondary values. CT and VT are considered.

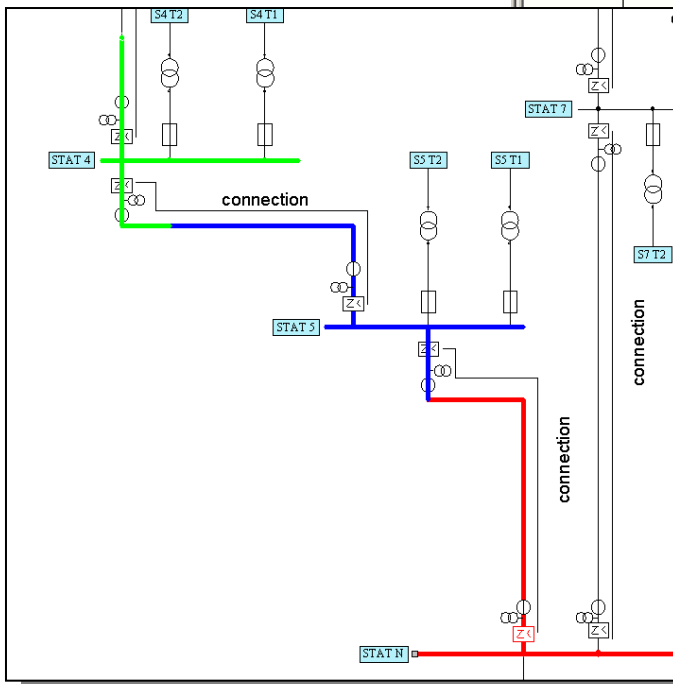
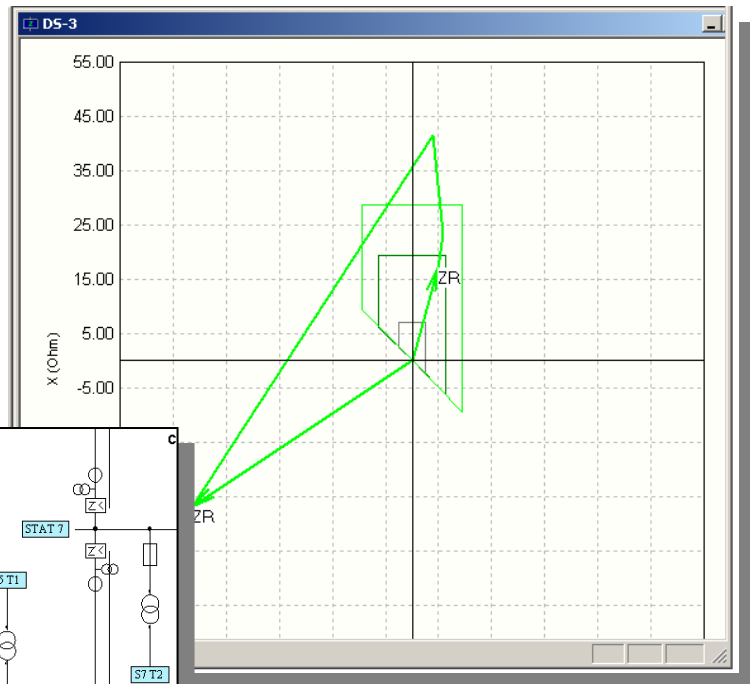

- Zones are colored in the single line diagram for a predefined relay.

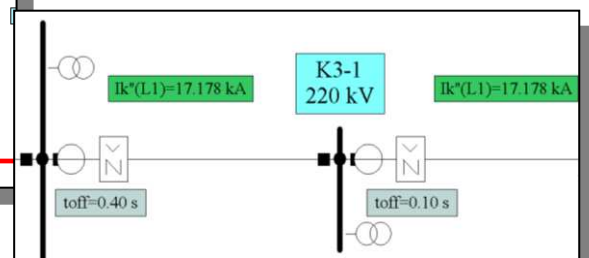

Probabilistic Reliability Analysis

Determining the frequency, average duration and cost of network component failures, leading to supply interruptions.

Consideration of

- Outage behavior (failure rate and repair times) of network equipment
- Network operation in normal state and for multiple order network contingencies
- Admissible short-time component overloading
- Protection concept including protection failures
- Realistic generation patterns and load curves

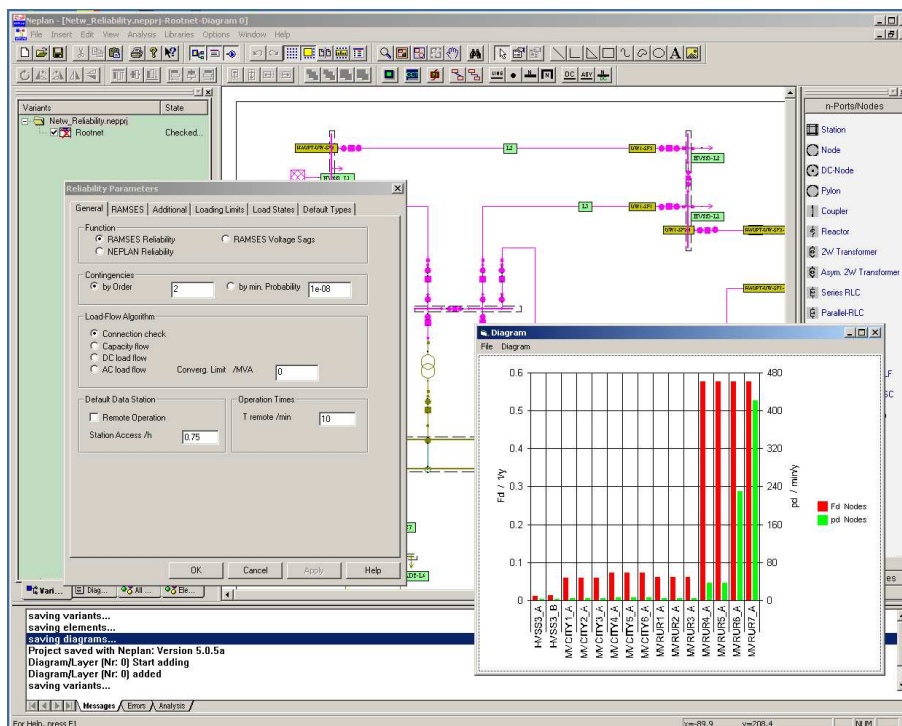

Reliability Analysis is imperative for

- Optimum asset allocation and cost-benefit analysis for investments in transmission and distribution networks
- Design and evaluation of innovative substation layouts
- Weak-point analysis in existing networks
- Design of automation concepts in public and industrial distribution networks
- Detailed and objective discussion of network connection concepts for high-demand customers and power plants
- Cost-effective mitigation of power quality problems (voltage sags)
- Add-on for NEPLAN-Main – a tool to apply Reliability Centered Maintenance (RCM) Strategy, which leads to substantial reduction of maintenance expenses

Procedure of Reliability Analysis

Relevant component failures

Single order contingencies:

- Stochastic failures
- Common-Mode failures
- Spontaneous protection tripping

Second order contingencies:

- Overlapping independent stochastic outages
- Failure occurring during the maintenance of the backup components
- Protection failure or overfunction
- Multiple earth-faults

Calculated results

- | | | |
|---------------------------------------|----------------|-----------|
| - Frequency of supply interruptions | fd | in #/yr |
| - Probability of supply interruptions | qd | in min/yr |
| - Mean interruption durations | Td | in hrs |
| - Energy not served in time | Wd | in MWh/yr |
| - Interruption cost | C _d | in \$/yr |

Presentation of results

- Result values printed at load nodes in network plan
- Color shading of the network graph in dependence of the reliability results
- Various filter functions implemented for detailed analysis
- Integrated flexible diagram functions to visualize the calculation results
- Results fully exportable for use in tables and diagrams

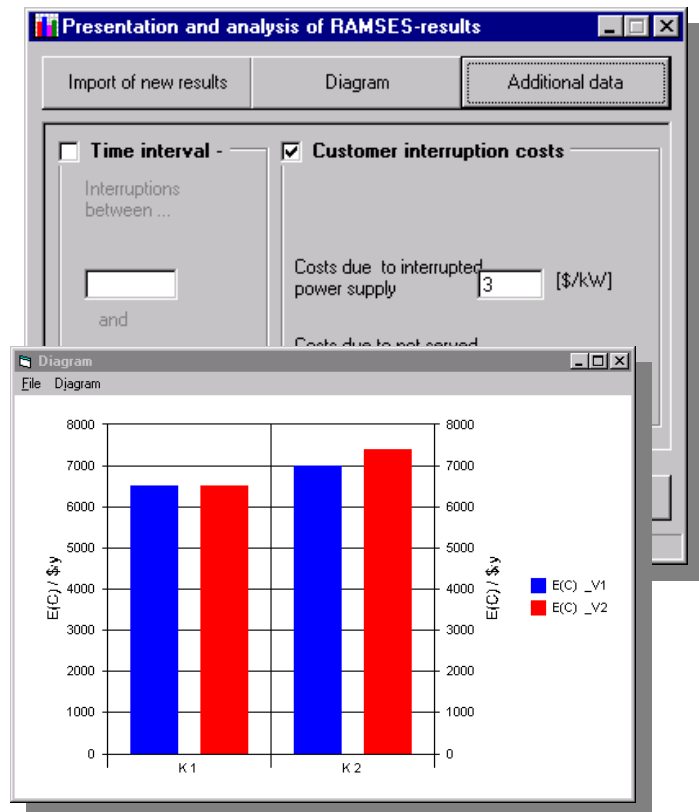

Evaluation functions

- Consideration of power/energy-specific interruption cost
- Filter to investigate component contributions to load node interruptions
- Copying of diagrams into clipboard
- Shading of network diagram in dependence of load node results
- Analysis of system reaction after faults

The NEPLAN® Dynamic Simulator is one of the most advanced on the market!

Simulator Modes

The NEPLAN simulator includes the following five calculation modes:

- RMS Transient Simulation in the DQ0 and ABC reference frame
- EMT Electromagnetic Transients Simulation in the DQ0 and ABC reference frame
- EMT Electromagnetic Transients Simulation using Dynamic Phasor Models.

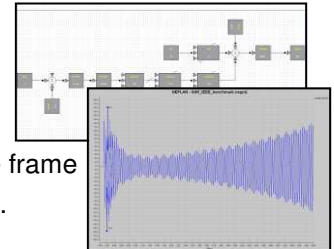

The RMS mode is used for simulating the slower electromechanical transients, where the electrical model quantities are described by their fundamental frequency components. The EMT simulations are performed for the simulation of fast electromagnetic transients using instantaneous values. The simulation of symmetrical network conditions (e.g. 3-phase faults) in DQ0 mode is much faster than in ABC mode. However the modeling in ABC mode is more flexible and is the preferable mode if unsymmetrical network condition must be simulated.

The use of Dynamic Phasor models is a completely new approach which is unique on the market. This mode allows the simulation of fast electromagnetic phenomena as accurate as in an EMT mode, but much faster.

No more struggling with initialization, since the simulator has sophisticated built in initialization algorithms.

Dynamic Models - Matlab®

- Extensive library with many AC, DC and controller models, e.g. exciters, turbines, regulators.
- For researchers: Most effective and flexible development of customized models in Matlab®. Existing Simulink® controllers may be run together with NEPLAN®
- Any variable (signal) of any component may be accessed to build up master controllers (e.g. wind park controllers or AGC - automatic generation control)

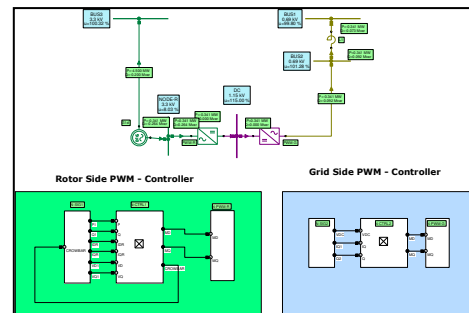
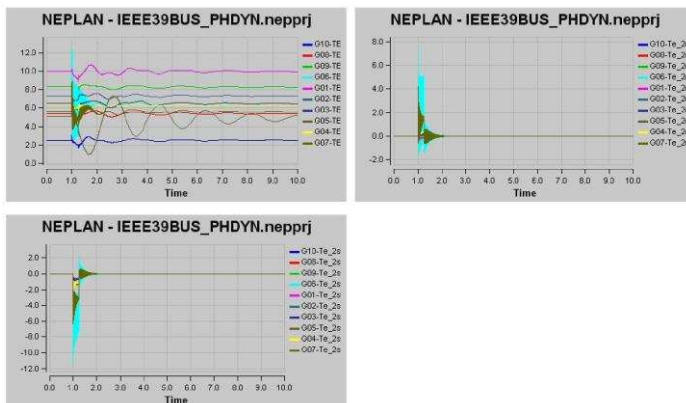

Fig.: Customized Wind Power Controllers (PWM, DFIG)



Applications

- Short-term, Mid-term and Long-term dynamic simulation.
- Sub-synchronous resonance with EMT simulation
- Load shedding and protection schemes
- HVDC-(light), FACTS, SVC design and regulation
- Machine dynamics and startup simulations
- PSS tuning with Eigenvalue and Sensitivity analysis
- Automatic generation control (AGC)

Protection Devices

- Min-max-relays (overcurrent, undervoltage, frequency,...): modeled with up to 4 tripping stages. E.g. various load shedding schemes may be simulated.
- Over current relays and fuses
- Pole slip relays, model includes binary input signals from external sources.
- Distance protection with any characteristic: pick-up and tripping stages, impedance diagrams, binary input signals from external sources.
- User defined protection described by equations or function blocks

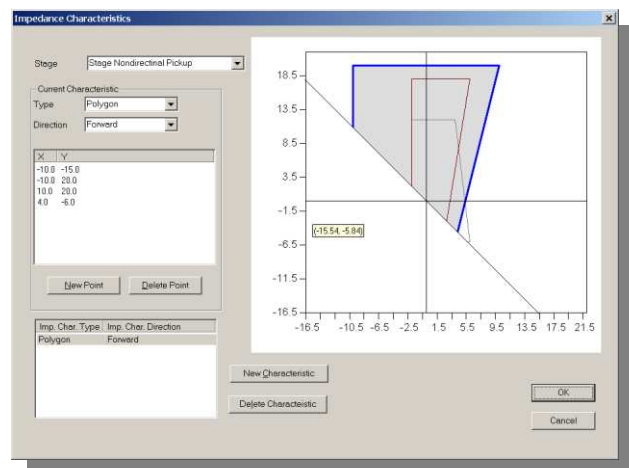
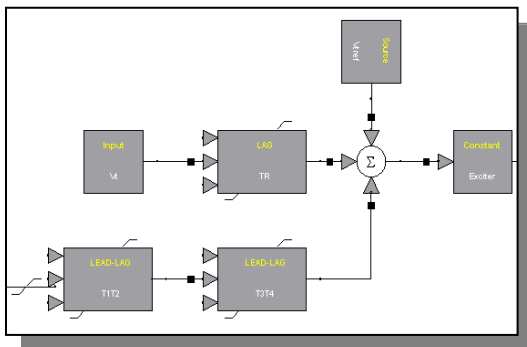
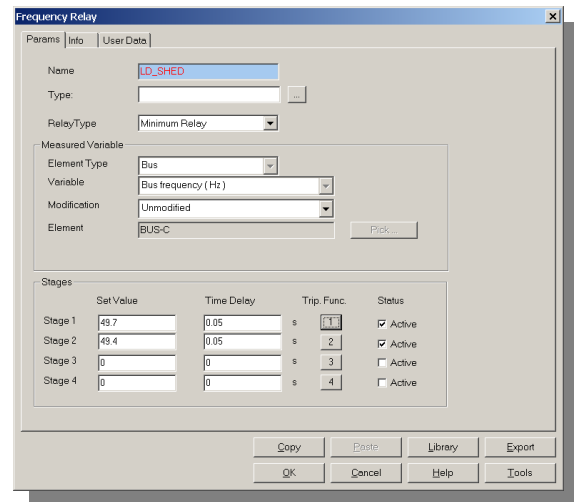

Disturbances

- Generation and storage of various disturbance cases.
- Each disturbance case may have more than one event.
- Definition of faults (symmetrical and unsymmetrical) on buses, bus elements, branches.
- Loss of generator excitation
- Different switching operations (feed-forward control in control circuits, cross coupling of protective devices, in/out of branches, etc.).
- Transformer tap modification.
- Load shedding scenarios (also in relation to frequency relay).
- Disturbances with function generators (step, ramp, sinusoidal function or combination).
- Start-up of motors with different start-up devices.
- User-defined disturbances (every variable can be modified in the network/control)

User-defined modeling in Dynamic Simulator

Application: Transmission – Distribution – Industrial - Generation



Researcher and developers need to have the ability to define their own power system component models. That could be amongst others:

- special load flow models
- special dynamic models for machines or loads
- controllers for wind power systems or FACTS devices
- wide area network controllers
- detailed model of protection devices
- etc.

NEPLAN® offers excellent functionalities to develop such user defined models (UDM) and integrate them into an existing NEPLAN® network model. Furthermore NEPLAN® data may be accessed by a C/C++ API, the NEPLAN® Programming Library (NPL). The model will be used in binary format, in order to protect the work and know how of the developer of such a UDM.

Modelling for Researchers

- Modelling with the C/ C++ API
- Function block diagram editor
- Modelling in Matlab® with DSAR
- Run NEPLAN and Simulink and use Simulink® defined models and controllers

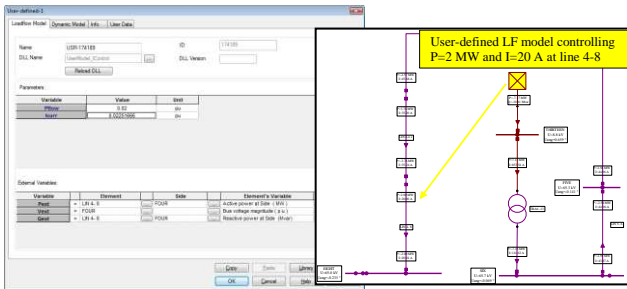

1) **Load flow models** may be defined with the NEPLAN® C/C++ API. Basically the load flow equations will be written in a C/C++ program. The compiled DLL file will then be assigned in the NEPLAN graphical editor. The dialog in NEPLAN show the parameters and signals which have to be defined for the model.

2) With the NEPLAN **function block drawing editor** the user may define graphically new dynamic models for controllers as well as for primary components and loads. The example on the right shows an exponential recovery load model.

3) The models may be described directly in Differential Switched-Algebraic State Reset Equations (DSAR) in Matlab®. The NEPLAN® - Matlab® interface automatically generates a binary DLL file which may be assigned to user defined NEPLAN® component. Parameters and external signals may be set in the NEPLAN dialog.

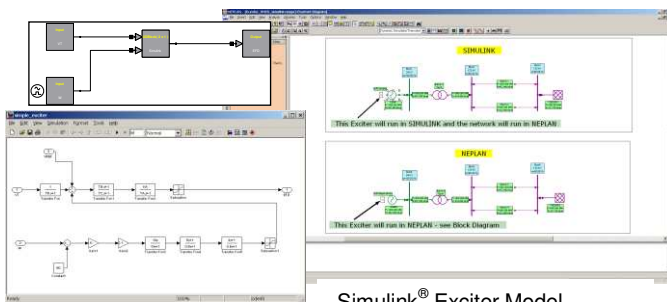

DFIG User defined controller in ABC simulation mode

4) It is possible to use directly the models and controllers from Simulink®. Simulink® and NEPLAN® are the running at the same time and in each time step NEPLAN® and Simulink® exchange data.

Current Transformer Saturation

Saturation check according to

- IEEE C37.110-1996
- IEC 60044-1 2003

Results

- Individual check or all CTs together
- Check for 3-phase and 1-phase faults
- Saturation criteria's according to standard are listed in tables
- Plot of ideal and distorted secondary CT current

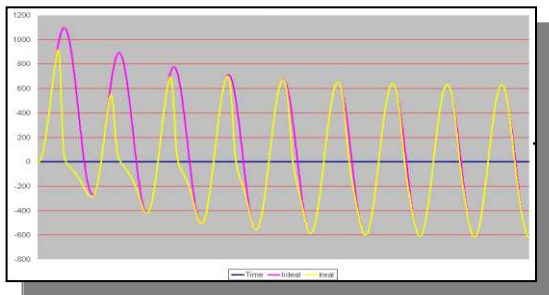
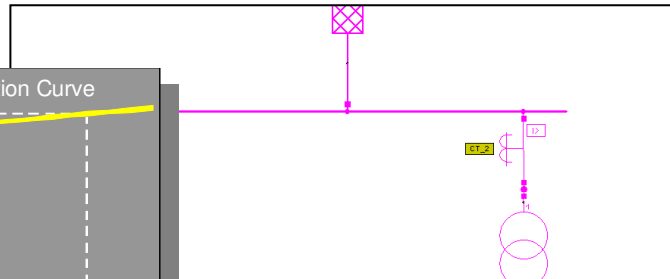
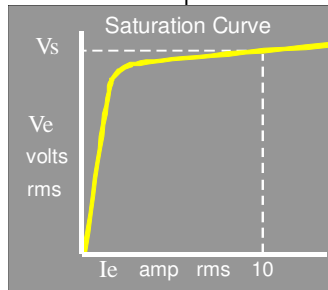

Current rating	Sec. taps	Rct Ohm	Rated output VA	Active
1				

Thermal Line Analysis

Thermal short circuit capacity

- DIN VDE 100 Part 540, IEC 865-1:1993 or ANSI
- Cable or overhead lines
- Worst fault location for thermal cable stress determined
- Permissible thermal cable current according to standards and line input values determined
- Tripping time of protection devices considered
- Permissible fault clearing time calculated
- Radial and meshed networks

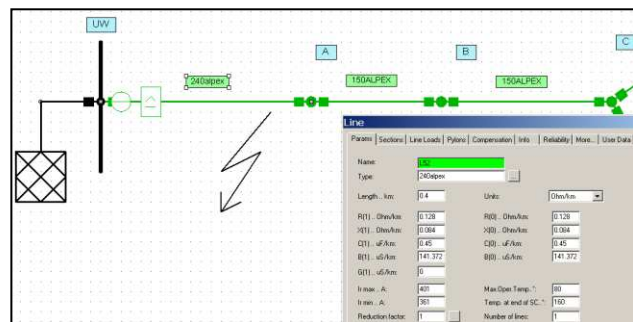

Line	Worst Fault at Node	Permissible Thermal Cable Current (kA)	Ik2 Line Current (kA)	Thermal SC Current for Fault Clearing Time (kA)	Fault Clearing Time (s)	Permissible Fault Clearing Time (s)	Checked	
2	L57	A	9.510	24.073	25.030	0.100	0.148	☑
3	L62	B	9.510	13.931	14.203	0.100	0.463	☑
4	L72	M	6.023	9.144	9.283	0.100	0.431	☑
5	L77	P	6.023	8.380	8.503	0.100	0.514	☑
6	L67	C	6.023	11.755	11.962	0.100	0.259	☑
7	L87	O	9.510	10.502	10.676	0.100	0.817	☑
8	L92	T	9.510	8.899	9.038	0.100	1.139	☑
9	L82	C	9.510	11.755	11.962	0.100	0.651	☑
10	L102	X	6.023	6.314	6.403	0.100	0.908	☑
11	L107	Z	6.023	6.746	6.842	0.100	0.795	☑
12	L97	L	6.023	7.508	7.620	0.100	0.641	☑
13	L112	Y	6.023	7.236	7.342	0.100	0.690	☑
14	L117	L	6.023	7.508	7.620	0.100	0.641	☑

This module is designed to reduce the size of a network model by replacing sets of buses and the network elements (lines, transformers,...) that connect them with a smaller but exact, numerically equivalent network. For a properly chosen set of buses, this equivalent network will have fewer buses and branches than the original, yet still provide the correct response to faults or load flow calculations in the unreduced portion.

The network can be reduced for

- symmetrical or asymmetrical short circuit calculations according to IEC909, IEC60909, ANSI/IEEE or superposition method and
- load flow calculation.

The reduced network gives the same short circuit or load flow results as the original network. Giving the nodes to be reduced, the program determines the boundary nodes automatically.

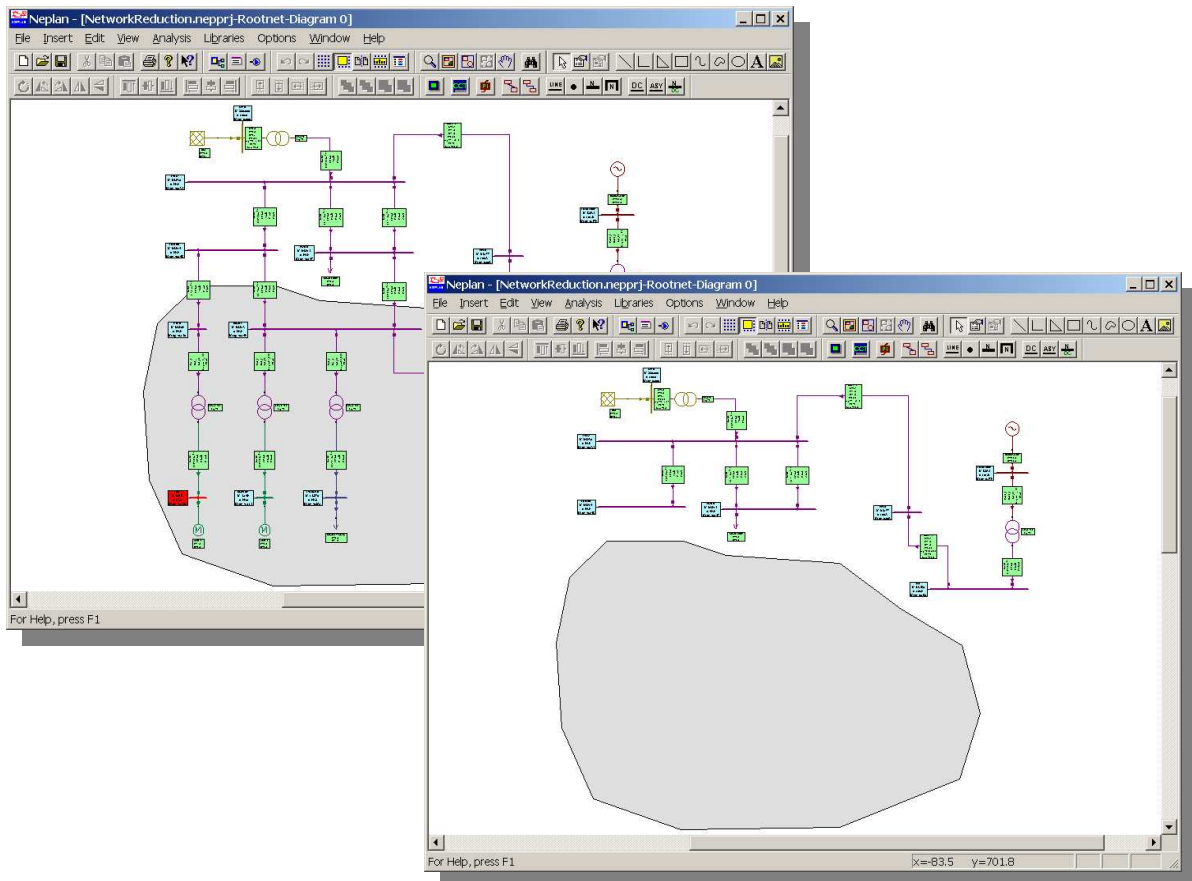

Input

- any network as for short circuit or load flow calculation
- nodes to be reduced during network reduction
- functions to select a complete network area to be reduced are available
- boundary nodes are determined automatically by the program

Output

- shunt and series equivalents, which can be saved in the data base
- the shunt and series equivalents consists of data for the positive, negative and zero system dependent on the type of network reduction (load flow or short circuit)
- for load flow network reduction boundary injections and boundary generators are calculated

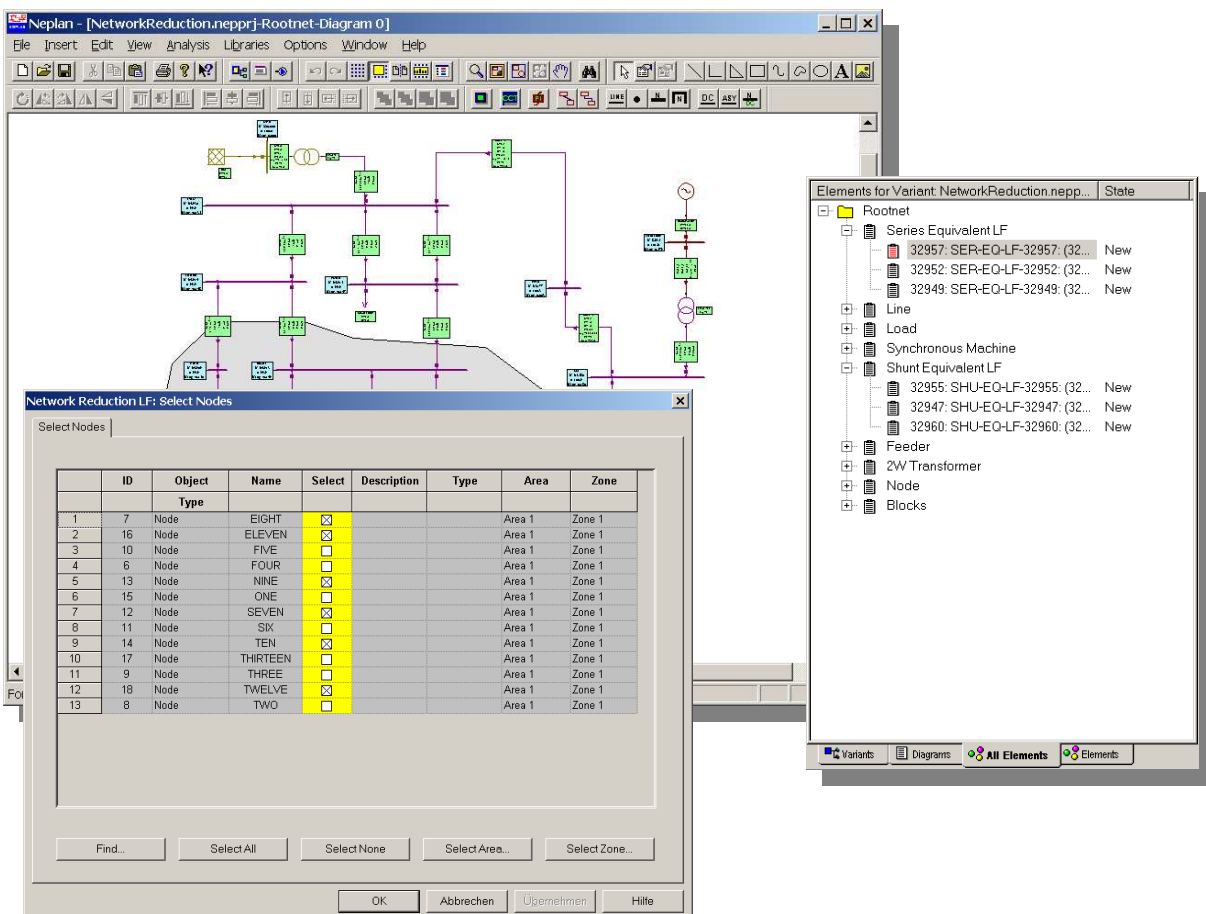

NPL - NEPLAN Programming Library

The NPL – NEPLAN Programming Library is a C/C++ API library, which includes functions to access NEPLAN data and calculation algorithms through a C/C++ user written program. Functions included among others are:

- Access any variable of any component
- Change any variable of any component
- Execute any analysis/calculation function
- Retrieve the calculation results
- Add new components to the network
- Delete components from the network
- Add and change the graphical information (x, y coordinates, symbols, etc.) of any component

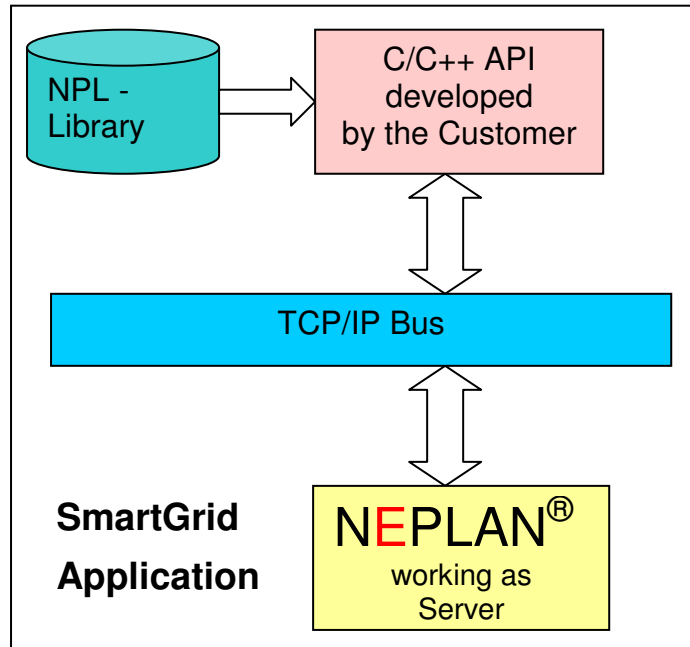

NPL - Applications

Many customized applications are possible:

- Implement NEPLAN with a NPL application in a SmartGrid environment
- Use NEPLAN in batch mode (e.g. running several load flows and short circuit calculations cases)
- Build customized interfaces (e.g. GIS, SCADA/DMS, DACF, CIM, etc.)
- Develop a network master controller with events (such as “if u <90% switch on reserve generator”) and run the application in a quasi stationary mode
- Checking protection behavior under various network conditions
- Use NEPLAN as server and connect NEPLAN to a TCP/IP bus. The client may send any NPL command to the NEPLAN server (e.g. run load flow, open switch, change load, etc)
- Use NEPLAN as On-line system and build a DMS application using the NEPLAN graphic editor and the analysis tools
- Researchers may even develop their own calculation algorithms (e.g. OPF, reliability, capacitor placement etc.)
- and much, much more.....

NPL – C++ Program example

```
//C ++ NPL Programm
void RunTestNPL()
{
    //Open a NEPLAN project file
    OpenNeplanProject(_T("NeplanDemoProject.neprj"));
    //run initial load flow
    RunAnalysisLF();
    //change the line length of line 'Line-1' to 0.5 km
    unsigned long ElementID=0;
    GetElementByName(_T("LINE"),_T("Line-1"), ElementID);
    if (ElementID > 0)
        SetParameterDouble(ElementID, _T("Length"), 0.5);
    //run load flow with changed line length
    RunAnalysisLF();
}

This colour means these are C++ NPL library functions
```

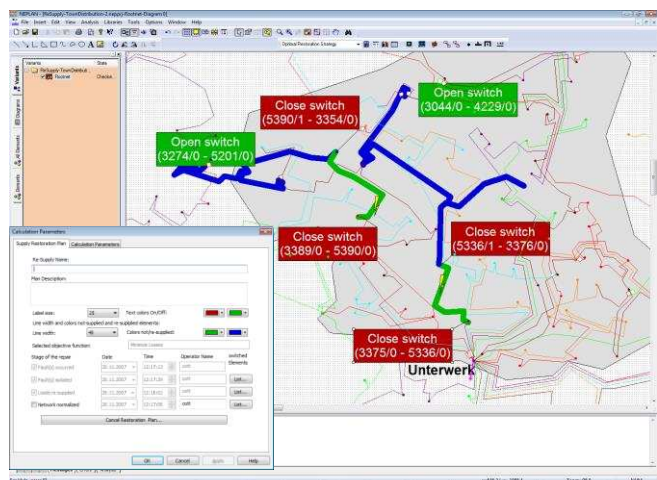

On-line DMS application: Optimal restorations after a fault

Load Flow with Load Profiles

Application: Transmission – Distribution



Input Data

- User-defined load and generation profiles (day, week, month and year factors)
- Unlimited number of profile types for consumers and generators (e.g. household, industry, ...)
- Import of measurement data and load profiles

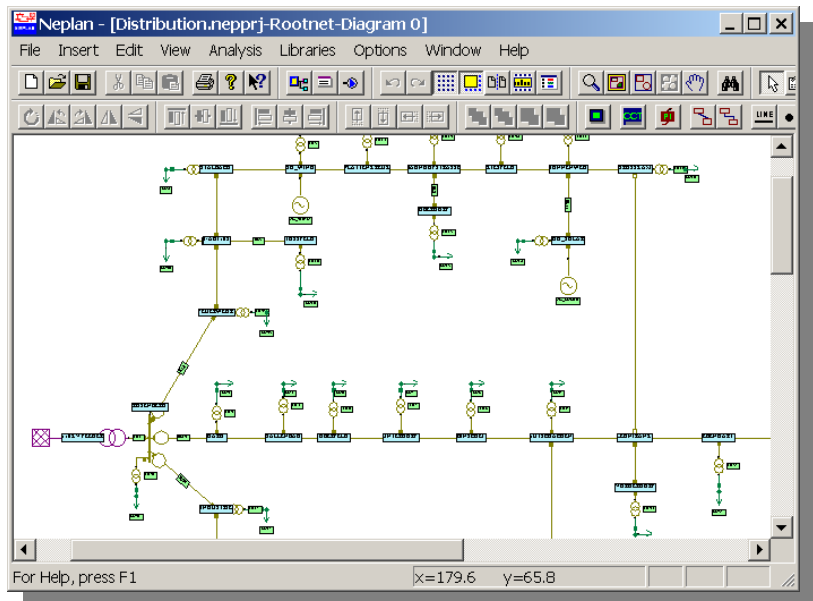

Load Flow with Load Profiles Parameters

Time | Options | Result Files

1 Load flow calculation

Year: 1998
 Month: January
 Weekday: Tuesday
 Daytime: 2 : 15

2 Load flow time simulation

From: 1998 To: 2020
 Month: January November
 Weekday: Monday Sunday
 Daytime: 0 : 0 24 : 0
 Time increment .min: 15

OK Abbrechen Hilfe

Calculations

- Single load flow calculation (load forecast) and time simulation
- User-defined time increment
- Combination of time intervals
- Load balancing mode: loads are automatically changed in the way that load flow results fit best to measured values (behaviors)

User Defined Scaling Factors

Scaling Factors | Day by Hours | Week by Days | Year by Months | Long Term by Years

Types: DF_BIG_INDUSTRY, DF_COMMERCIAL, DF_CONSTANT, **DF_DOMESTIC**, DF_HEATING, DF_HYDRO_POW_STAT, DF_INDUSTRY, DF_MOTORW_REST, DF_SOLAR_POW_STAT, DF_THERM_POW_STAT, DF_WIND_POW_STAT

Description: Domestic area, winter

Time	Factor
00:00	0.400
01:00	0.290
02:00	0.260
03:00	0.250
04:00	0.260
05:00	0.270
06:00	0.310
07:00	0.400
08:00	0.600
09:00	0.650
10:00	0.650
11:00	0.700
12:00	0.920
13:00	0.650
14:00	0.620
15:00	0.620
16:00	0.630
18:00	0.920
20:00	1.000
21:00	0.850
22:00	0.650

Q-factor: 0.9000, 1.0000, 1.0000, 1.0000, 0.8000, 0.5000, 0.4000

OK Abbrechen Library... Hilfe

Load Flow with Load Profiles

Application: Transmission – Distribution



Results

- Time behavior and value range charts
- Characteristics of network, elements and nodes (voltages, currents, loadings, power, MW losses, energy losses,...)
- Any system quantities may be plotted, or compared

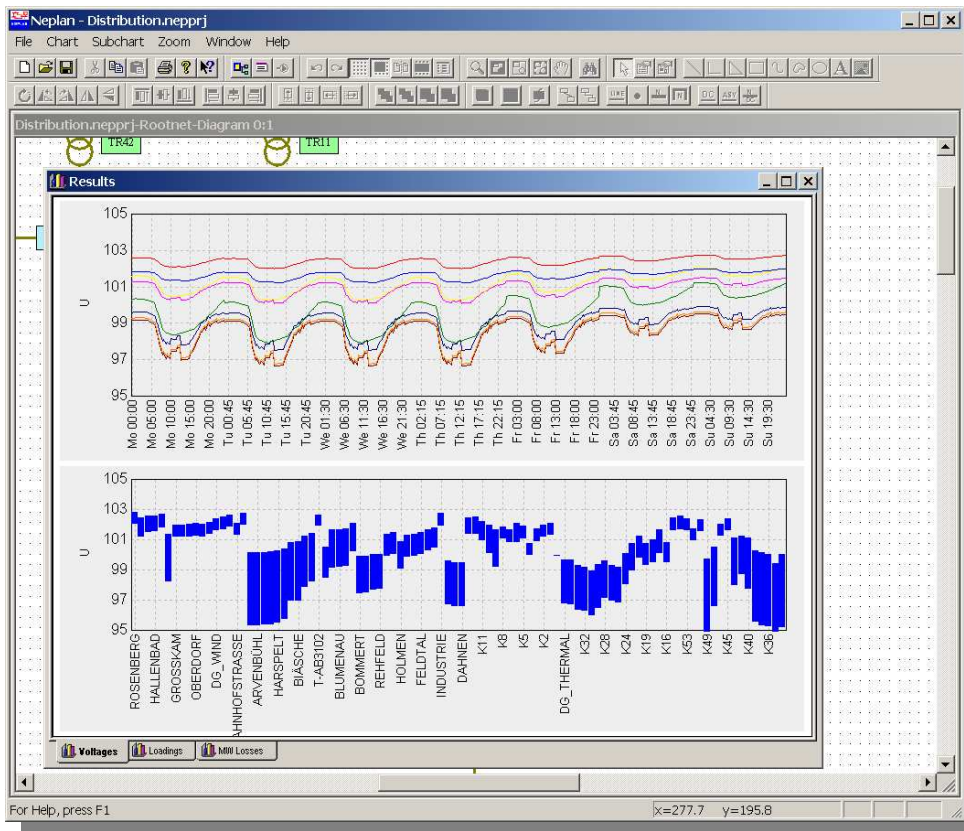
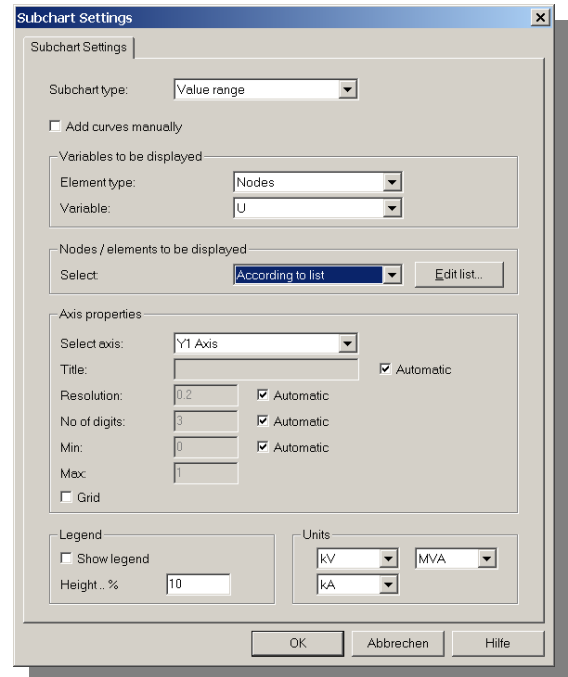

Optimal Network Restoration Strategy

Application: Distribution



This module is designed to study the impact of single forced (e.g. fault on a line) or planned outages on the electrical distribution system. It finds the optimal switching plan to restore electrical power to customers. This module may be used for **off-line** application to pre-define strategies in case of outages or as **on-line** application to help the network operator to find quickly the correct strategy after a fault has occurred.

The following objective functions are implemented:

- Minimize network losses
- Minimize the number of overloaded elements
- Minimize the average loadings of the elements
- Maximize the average voltage

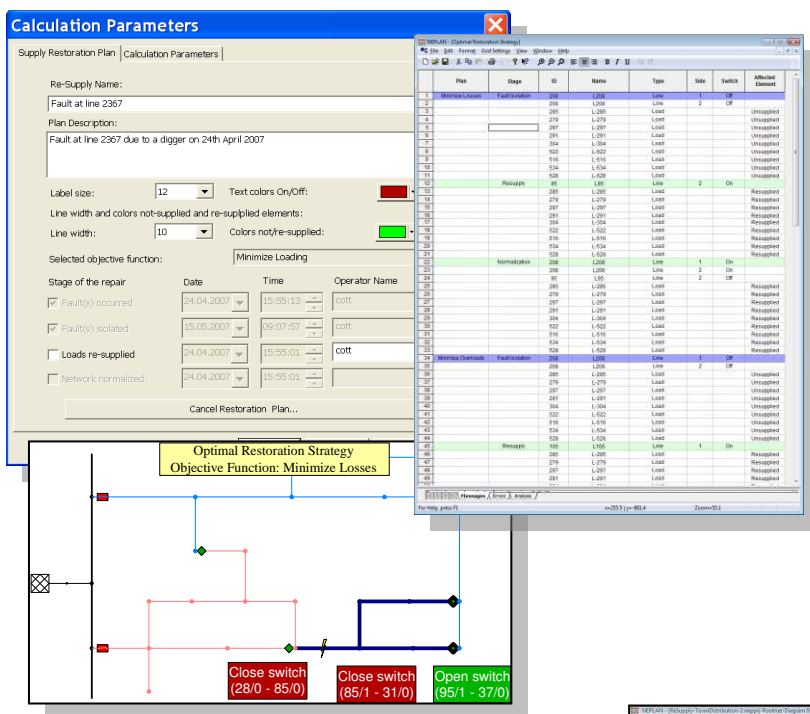

Restoration Stages

- Four stages in the restoration strategy will be evaluated and may be stored in a fault history database:
 - Occurrence of the fault
 - Isolation of the fault -> NEPLAN shows the unsupplied customers
 - Re-Supply of customers which are affected by the fault -> NEPLAN shows which customer are re-supplied again
 - Normalization of the network after the repair of the fault
- All stages of the selected optimal restoration plan with the new switch positions will be graphically displayed on the single line diagram

DMS On-Line Application

- Results with the new switch positions of all re-supply stages, including all objective functions are displayed as spreadsheet tables or can be accessed as text file for further evaluation (e.g. in DMS applications)
- All dialogs and restoration algorithms are available through a C++ API, the NPL - NEPLAN Programming Library. With NPL NEPLAN data and functions can be accessed with a user written C++ program. This allows building up customized restoration strategies for network operators.

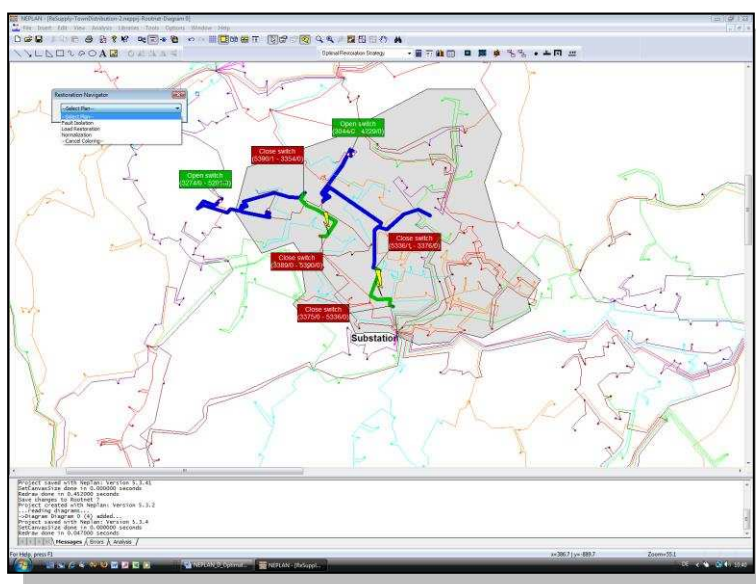

More information and free DEMO www.neplan.ch

Feeder Reinforcement

Application: Distribution



Economic cable dimensioning

- Selection of most economic cable cross section from a predefined cable library over a given planning period and load states in distribution networks
- Conditions are cable overloads and over-/under-voltages
- Optimization in respect of losses or voltage drop
- Load condition given as load profiles or load state after planning period
- Load utilization time is calculated or given as input value
- Library with cable material costs
- Five different types for installation costs
- Reinforcement can be done for all feeders or feeder-wise

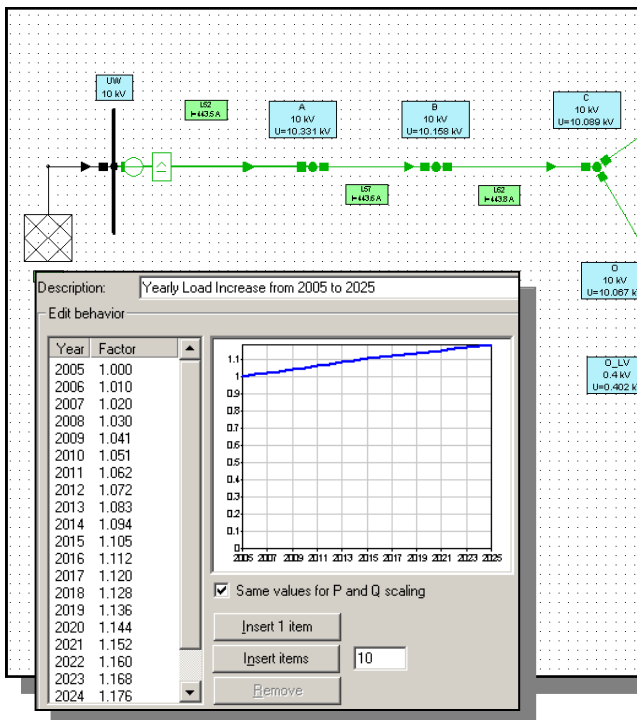

Feeder Reinforcement Parameter

Parameter

Feeder Reinforcement according to

Cable Sizing with Load flow LF Parameter...

Cable Sizing with yearly load increase (profiles)

Thermal Analysis (Short Circuit) SC Parameter...

Thermal Analysis

DIN VDE 100 Part 540 ANSI

DIN VDE 0103 = IEC 885-1:1993 With Feeder Selection

Cable Sizing

Make Sizing for given period

Base Year: Period .. years:

Pay back period .. years:

Interest rate .. %: Un .. kV:

Energy costs .. Units/kWh: Consider loads at low voltage

Currency Units: Calculate utilization time

Load utilization time .. h/a:

Cable cost file (*.txt):

NEPLAN Library:

Cable installation costs per meter in Currency Units

Type 1: Type 3: Type 5:

Type 2: Type 4:

Load state after PayBack Period for Loadflow (without yearly load increase)

Loading file (*.ndb):

OK Cancel Apply Help

Results

No.	Year	Line to be Replaced	From	To	Caused by Line Overload	Total Line Length	Cable Material Costs	Installation Costs	Total Cable Costs	Losses before Replacement	Losses after Replacement	Loss Reduction	Selection Criteria	Best Cross Section (Voltage opt.)	Most economical Cross Section	Minimum Length
						m	Kr	Kr	Kr	kW	kW	Kr	Kr/Volt	mm2	mm2	m
1	2005	L57	A	B	<input type="checkbox"/>	1000.0	320000.0	0.0	320000.0	122.9	74.7	668639.1	-2841.7	240	240	1000.0
2	2008	L62	B	C	<input type="checkbox"/>	400.0	128000.0	0.0	128000.0	54.5	33.3	280300.7	-5863.3	240	240	400.0
3	2013	L52	UW	A	<input type="checkbox"/>	400.0	128000.0	0.0	128000.0	65.8	40.2	310922.1	-3266.3	240	240	400.0
4	2017	L82	C	O	<input type="checkbox"/>	300.0	96000.0	0.0	96000.0	12.9	7.9	79692.3	1495.7	240	240	300.0
5	2018	L67	C	M	<input type="checkbox"/>	500.0	160000.0	0.0	160000.0	39.6	15.7	200443.5	-852.5	240	240	500.0
6	2019	L92	T	L	<input type="checkbox"/>	600.0	192000.0	0.0	192000.0	15.8	9.7	94623.0	5676.8	240	240	600.0
7	2021	L87	O	T	<input type="checkbox"/>	500.0	160000.0	0.0	160000.0	14.2	8.7	82179.9	5261.5	240	240	500.0
8	2024	L102	X	I	<input type="checkbox"/>	500.0	160000.0	0.0	160000.0	2.8	1.1	23521.5	10706.5	240	150	174.0



This module is used for the assessment of the network disturbances according to the D-A-CH-CZ technical rules, which has been released by the utility associations

- VDN – Verband der Netzbetreiber in Germany,
- VSE – Verband Schweizerischer Elektrizitätsunternehmen in Switzerland,
- VEÖ – Verband der Elektrizitätsunternehmen in Austria and
- CSRES – Ceske sdruzeni rozvodnych Energetických Spolecnosti in Czeck Republik.

Due to the increased employment of power electronics and the thereby associated rise in nonlinear consumers at all network levels, disturbances on the networks occur at an increasing rate, which can make themselves noticeable by undesired changes in

- the level
- the waveform
-

of the mains voltage. As a consequence of this, other electrical devices and plants connected to the network can be disturbed through interference. One differentiates between:

- Functional failures
- Malfunctions
- Direct or indirect damage including possible consequential damage.

The possible disturbances are dependent on the amplitude, the frequency and the duration of the network disturbances, as well as the degree of spread of certain types of devices. In addition, the simultaneity factor of the electrical devices and plants, that in operation cause network disturbances, is to be taken into account.

The disturbances on the network itself can manifest themselves e.g. in the following manner:

- Deterioration of the power factor (increase in the transmission losses and reduction in the efficiency)
- Insufficient ground-fault compensation.

It is in the interest of all

- to ensure the adherence to a balance between additional emitted disturbances in the network and the protection of other electrical devices and plants connected to the network.
- to meet the significantly increased quality demands of modern devices and processes despite the rising pressure of costs.
- to maintain the existing high level of quality in the face of the changing generation structures and the additional requirements on the networks resulting therefrom.

For this reason, the network operators must have the possibility of keeping the network disturbances caused by the electrical devices and generating stations connected to their networks and their consequences within tolerable limits, even under changing framework conditions.

For the purpose of an appropriate distribution of the resulting responsibility, for this the following fields of action come into consideration:

- suitable design and operative measures in the networks, under consideration of the objective quality requirements and the economic justification.
- an adapted setting of limiting values for requirements on electrical devices and equipment in the relevant EMC-standards as well as their observance.
- if necessary, the imposed duty to undertake corrective measures to reduce network disturbances

This method of procedure is supported by several statutory regulations at European or individual member state level.

Input values

- Installation can be a motor, welding machine, converter drive motor, wind power plant, photo voltaic plant, biogas plant, small water plant, hybrid electric vehicles, etc.
- Network connection point
- Type of connection: 3-phase, 2-phase, 1-phase connection
- Apparent power of the installation (equipment or plant). Maximum power change.
- Power consumer or generator.
- Cos(phi) of the power or current change
- Repeat rate of power or current change per minutes
- Temporary return feed possible.
- Assignment to harmonic group

Assessment criteria

- Voltage change
- Voltage rise
- Flicker
- Harmonics
- Voltage unbalance
- Measurements
- Data for the reactive power compensation

Results

- Connection permissible or only with measurements
- Maximum voltage change or rise
- Short- and long-term flicker intensity Pst, Plt
- Total harmonic load
- Allowed harmonic current/voltage limits, comparison with measured I/U-harmonics
- Evaluation of voltage unbalance
- Maximum impedance for minimum absorption effect for compensation (ripple control systems)

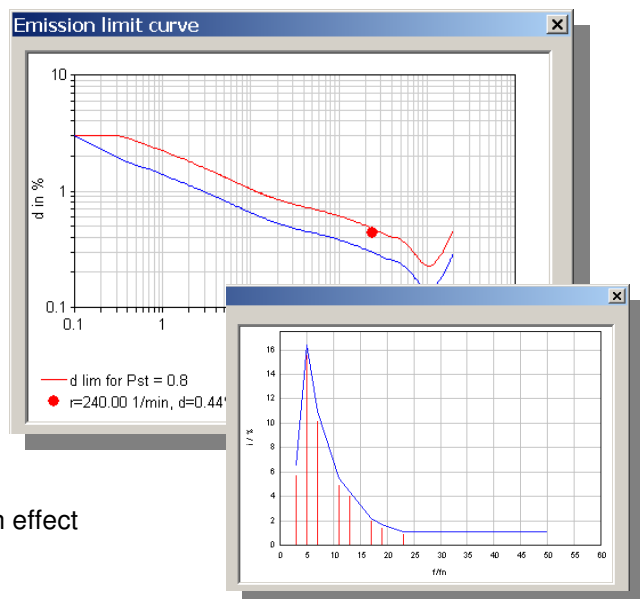

Low Voltage Analysis

Application: Distribution



Characteristics

- Calculation of the voltage drop and cable loadings with variable simultaneity factor for consumer types.
- Simultaneity factor is dependent on the number of loads of the same type in a feeder or line.
- Pre-defined consumer types are: household, warm water treatment, continues-flow water heater, storage warm water treatment, night heat storage.
- Consumer types and their characteristic can be defined by the user.
- Calculation of the minimum 3-phase and 1-phase short circuit.
- Checks the breaking condition
- Checks of the selectivity of fuses

Results

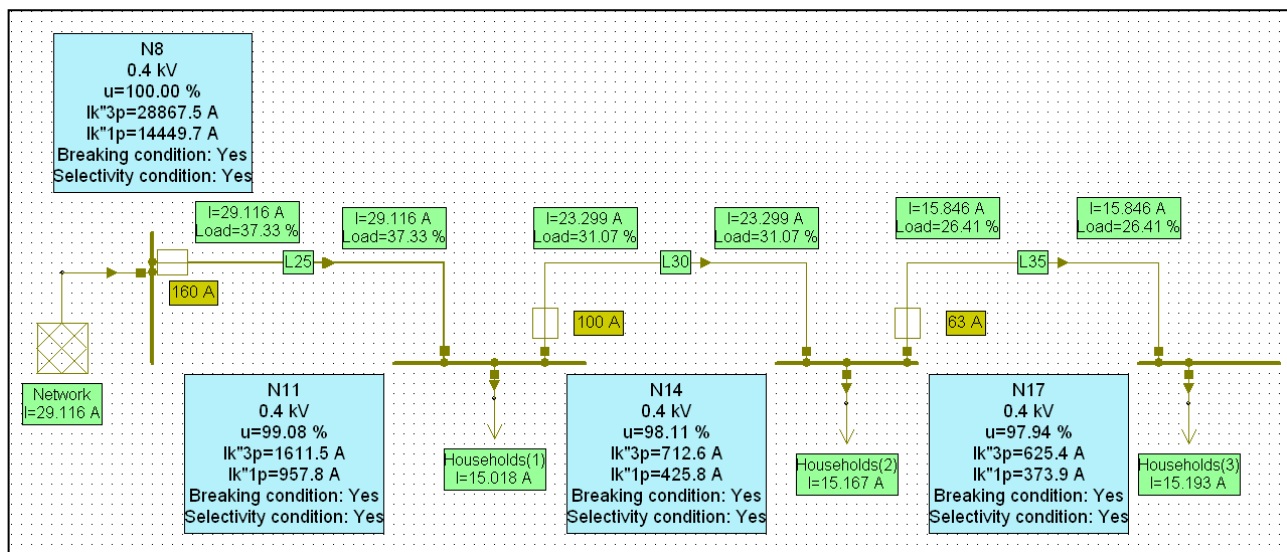

	ID	Node	Description	U	u	U Angle	Ik''1p min	Ik''1p min Angle	Ik''3p min	Ik''3p min Angle	Ib	Breaking condition	Selectivity condition	Bad fuse for breaking	Bad fuse for selectivity
				V	%	°	A	°	A	°	A				
1	8	N8		400	100	0	14449.7	-88.1	28867.5	-84.3	29.1	<input checked="" type="checkbox"/>	<input checked="" type="checkbox"/>	-	-
2	27949	N11		396.3	99.08	-0.7	957.8	-70	1611.5	-69.6	29.1	<input checked="" type="checkbox"/>	<input checked="" type="checkbox"/>	-	-
3	27955	N17		391.8	97.94	-1.6	373.9	-69.2	625.4	-69	15.8	<input checked="" type="checkbox"/>	<input checked="" type="checkbox"/>	-	-
4	27952	N14		392.4	98.11	-1.5	425.8	-69.3	712.6	-69.1	23.3	<input checked="" type="checkbox"/>	<input checked="" type="checkbox"/>	-	-
5			Pv= 0.1 kW Qv= 0.6 kVar									<input type="checkbox"/>	<input type="checkbox"/>	-	-

Phase Swapping

Application: Distribution



Characteristics

- Phase Swapping allows to reduce the unbalance in the phases by re-phasing single/two phase loads and lines
- Re-phasing can be done to:
 1. Minimize the kW losses,
 2. Minimize kVA Unbalance (apparent power)
 3. Minimize A Unbalance (current).
- Max. number of swapping can be defined
- Re-phasing works feeder-oriented
- Shows the unbalance and losses before and after re-phasing
- Manual re-phasing can be done
- Single-phase load flow can directly be started from Feeder Management

Feeder Management - Phase Balancing

Feeder Details | Phase Balancing

Feeder: EBENHART F1

Substation	Name	Unbalance [%]
EBENHART	F1	28.79
EBENHART	F6	48.37
EBENHART	F12	42.55

Display Options: Display 3 phases
Unbalance criteria: I | S

Buttons: Load Flow, Param..., Short Circuit, Param...

Lines:

ID	Name	Phases	I(L1) [A]	I(L2) [A]	I(L3) [A]	Unbalance [%]
166	LI6	L1L2L3N	85.38	98.36	38.20	48.37
170	LI7	L1L2L3N	68.16	81.34	21.05	62.98
174	LI8	L1L2L3N	68.18	81.37	0.25	99.49
178	LI9	L1L2L3N	34.12	81.38	0.22	110.97
182	LI10	L1L2L3N	0.08	81.48	0.08	199.40
174370	L_AS1	L3N	0.00	0.00	21.22	0.00
174237	L_AS2	L3N	0.00	0.00	21.22	0.00

Loads and Shunts:

ID	Name	Phases	S [kVA]	I [A]
487	LO5	L2N	922.00	27.00
174540	L-174540	L1N	400.00	12.00
496	LO14	L1N	400.00	12.00
174234	LA_AS2	L3N	250.00	7.20
486	LO4	L1L2L3N	600.00	866.00

Results

Feeder Management - Phase Balancing

Parameter: Objective: Minimize kW Losses, Max. Number of Swappings: 10

Include single-phase lines: Minimum Load ... kVA: 0
Include two phase lines: Minimum Current ... A: 0
Include three-phase lines:

Feeder to balance and initial Loadflow: Feeder: F6, Starting line: LI6

Step	Select	Line/Load	Rephasing	Losses kW	kVA Unbalance %	A Unbalance %	I(L1) A	I(L2) A	I(L3) A
1	1	LO14	L1->L3	34.73	32.7	33	50.9	98.4	72.6
2	2	L_AS1	L3->L1	34.51	32.7	33.2	72.0	98.4	51.2

Step	Feeder	Line/Load	Rephasing	Losses kW	kVA Unbalance %	A Unbalance %	I(L1) A	I(L2) A	I(L3) A	S(L1) kVA	S(L2) kVA	S(L3) kVA	Objective	3-phases lines
1	0	F6		36.28	48.3	48.3	85.3	85.3	85.3	1010.75	1155.79	450.65	kW Losses	Yes
2	1	LO14	L1->L3	34.73	32.7	33.0	50.9	98.4	72.6	604.66	1155.64	853.24		
3	2	L_AS1	L3->L1	34.51	32.7	33.2	72.0	98.4	51.2	853.81	1155.87	603.68		

Optimization in Distribution Networks

Application: Distribution



Goal

Minimization of MW losses and improve voltage levels with the following optimization criteria (all optional):

- Optimal separation points (least loss switch configuration)
- Optimal compounding for transformers
- Optimal power factors of disperse generators
- Optimal set voltage for on-load transformers
- Optimal LV/MV-transformer tap setting
- For normal operation and N-1 operation

Limits

- Voltage limits at MV and LV-side (user-defined)
- Thermal limits of the cables and transformers

Load situation

- Load range defined by a maximum and minimum with scaling factors and load data import
- User defines loads and disperse generators to be scaled

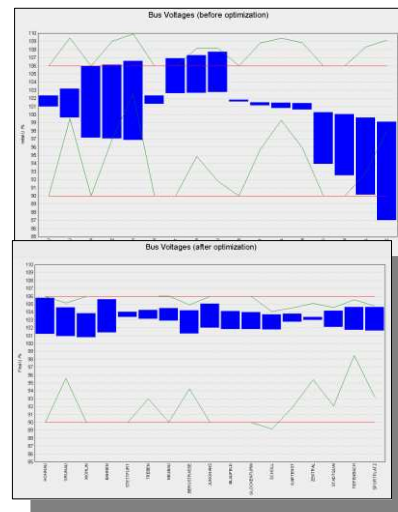
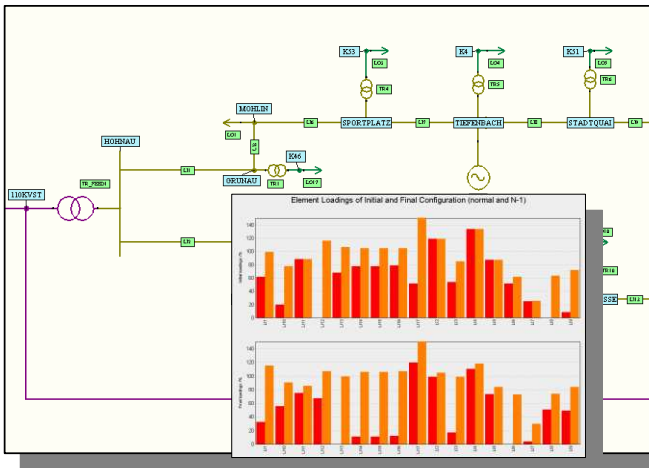
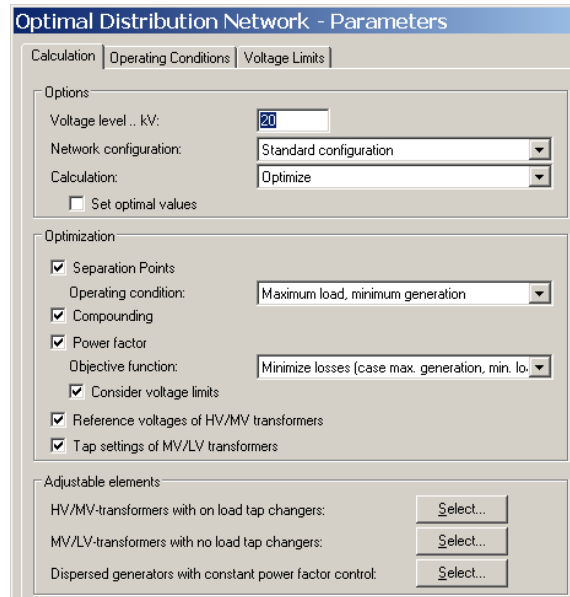

before

after

Optimal Capacitor Placement

Identifies key locations in radial primary feeders, where the placement of shunt capacitors minimizes the MW losses.

Results are:

- the bus of the primary feeder, where a shunt capacitor would be located,
- the MVAR size of the capacitor, and
- the additional reduction in MW losses (in %).

Load factor	Bus ID	Bus Name	Size kVar	Losses	Additional Loss reduction
				MW	%
0.6				0.0534	
	6783	B6	1210	0.0379	29
1	6820	B3	940	0.0350	3.74
				0.1584	
5	6783	B6	2130	0.1085	30.6
	6820	B3	1690	0.102	4.12

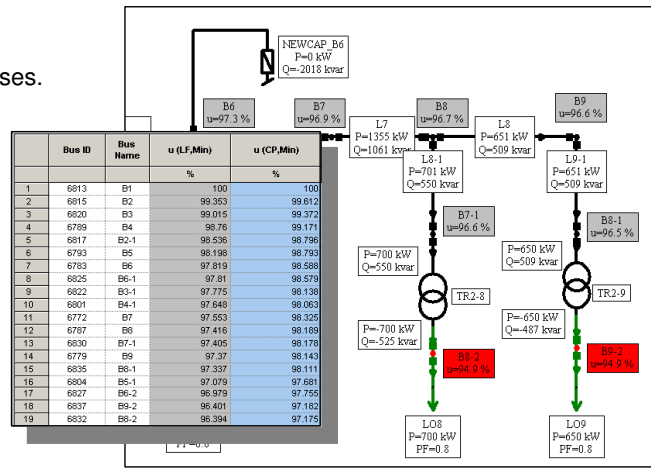



NEPLAN Maintenance (Reliability Centered Maintenance)

A good overview over different maintenance strategies and the NEPLAN-Maintenance philosophy can be found on this web-site:

www.neplan.ch/downloads/public/NEPLAN-Maintenance-Strategies_e.pdf

The main features of the NEPLAN-Maintenance module are:

- Available sub-modules are:
 - o HV Components
 - o HV AIS Substations
 - o HV GIS Substations
 - o HV/MV Overhead line
 - o MV Substations
 - o MV Local Substations
 - o MV Cables
- Data can be stored in any database (e.g. Oracle, MS-Access, SQL Server etc.)
- Allows easy integration to existing ERP systems (e.g. SAP)
- Assessment criterion can be added or changed by the user
- Allows quickly to assess the conditions of the components
- Different charts give a useful overview over the overall conditions of the components
- A budgeting evaluation tools is available, which calculates the costs for the following maintenance strategies:
 - o TBM Estimation (estimated time based maintenance)
 - o TBM (time based maintenance)
 - o CBM (condition based maintenance)
 - o RCM (reliability based maintenance)
- **Integrates smoothly with our famous NEPLAN-Reliability module**
- Can be excellently used a for reinvestment strategies

Component Assessment in NEPLAN-Maintenance

The picture below shows on the left side the assessment sheet of the current component. The diagram shows all condition (y-axis) and all importance (x-axis) of all components (in this case circuit breakers). The actual circuit breaker to assess is colored differently. The user can define any filter to reduce the amount of displayed components.

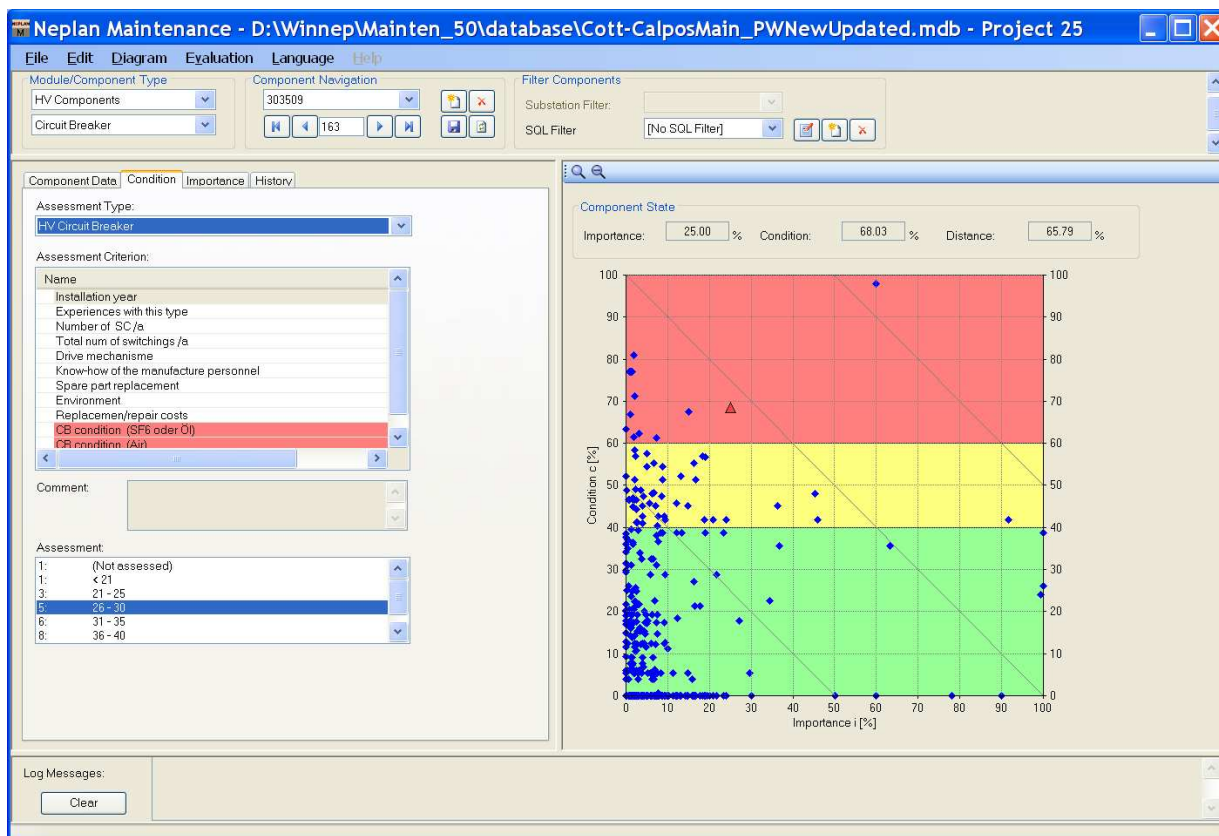

The condition of each component can easily be assessed with the freely configurable assessment sheets.

Budgeting Evaluation Tool in NEPLAN-Maintenance

In NEPLAN-Maintenance a budgeting tool is included, which allows evaluating the costs of the different maintenance strategies:

- TBM Estimation (estimated time based maintenance)
- TBM (time based maintenance)
- CBM (condition based maintenance)
- RCM (reliability based maintenance)

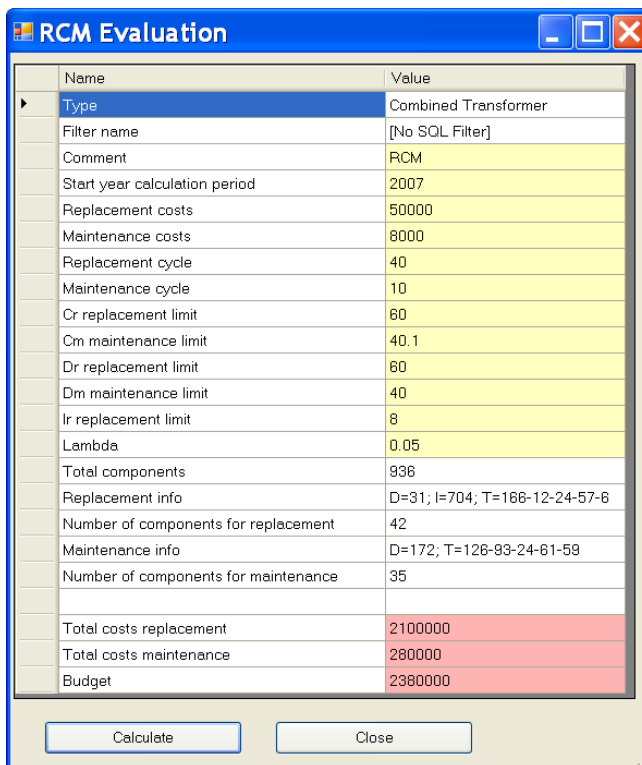

Name	Value
Type	Combined Transformer
Filter name	[No SQL Filter]
Comment	RCM
Start year calculation period	2007
Replacement costs	50000
Maintenance costs	8000
Replacement cycle	40
Maintenance cycle	10
Cr replacement limit	60
Cm maintenance limit	40.1
Dr replacement limit	60
Dm maintenance limit	40
Ir replacement limit	8
Lambda	0.05
Total components	936
Replacement info	D=31; I=704; T=166-12-24-57-6
Number of components for replacement	42
Maintenance info	D=172; T=126-93-24-61-59
Number of components for maintenance	35
Total costs replacement	2100000
Total costs maintenance	280000
Budget	2380000

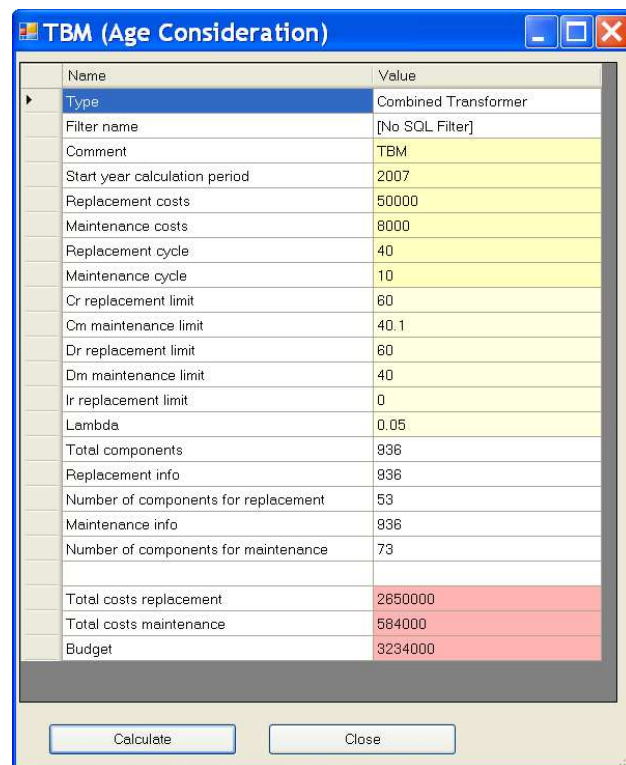

Name	Value
Type	Combined Transformer
Filter name	[No SQL Filter]
Comment	TBM
Start year calculation period	2007
Replacement costs	50000
Maintenance costs	8000
Replacement cycle	40
Maintenance cycle	10
Cr replacement limit	60
Cm maintenance limit	40.1
Dr replacement limit	60
Dm maintenance limit	40
Ir replacement limit	0
Lambda	0.05
Total components	936
Replacement info	936
Number of components for replacement	53
Maintenance info	936
Number of components for maintenance	73
Total costs replacement	2650000
Total costs maintenance	584000
Budget	3234000

At your fingertips: budgeting evaluation of RCM and TBM can be easily compared

Chart Evaluation Tool in NEPLAN-Maintenance

The integrated chart manager shows for example the influence of each criterion to the overall conditions of all components. Each criterion can be assigned to a cluster (e.g. operating condition, component type, etc.). NEPLAN allows evaluating the overall conditions according to these clusters.

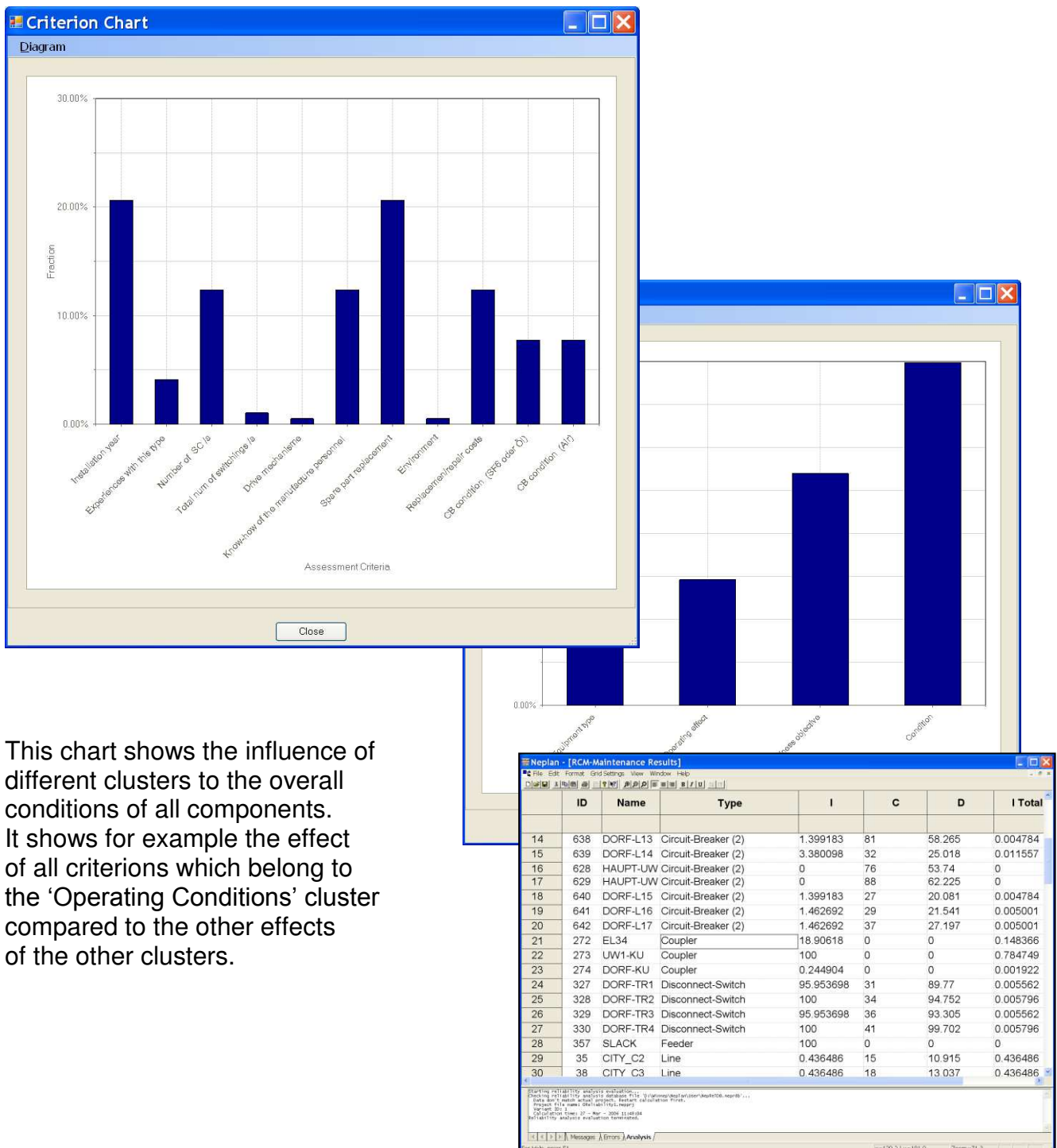

This chart shows the influence of different clusters to the overall conditions of all components. It shows for example the effect of all criteria which belong to the 'Operating Conditions' cluster compared to the other effects of the other clusters.

Integration with NEPLAN-Reliability Module

The NEPLAN-Maintenance module can make use of the calculated results of our famous NEPLAN-Reliability module. The NEPLAN-Maintenance module integrates smoothly to the NEPLAN single line diagram. The conditions C, importance I and the distances D (function of condition and importance, $D = f(C, I)$) can be displayed on the single line diagram. The coloring according to C, I and D shows very quickly which components must be replaced or maintained first.

The NEPLAN-Maintenance module is at the moment the only RCM module on the market, which integrates, with a robust network reliability module.

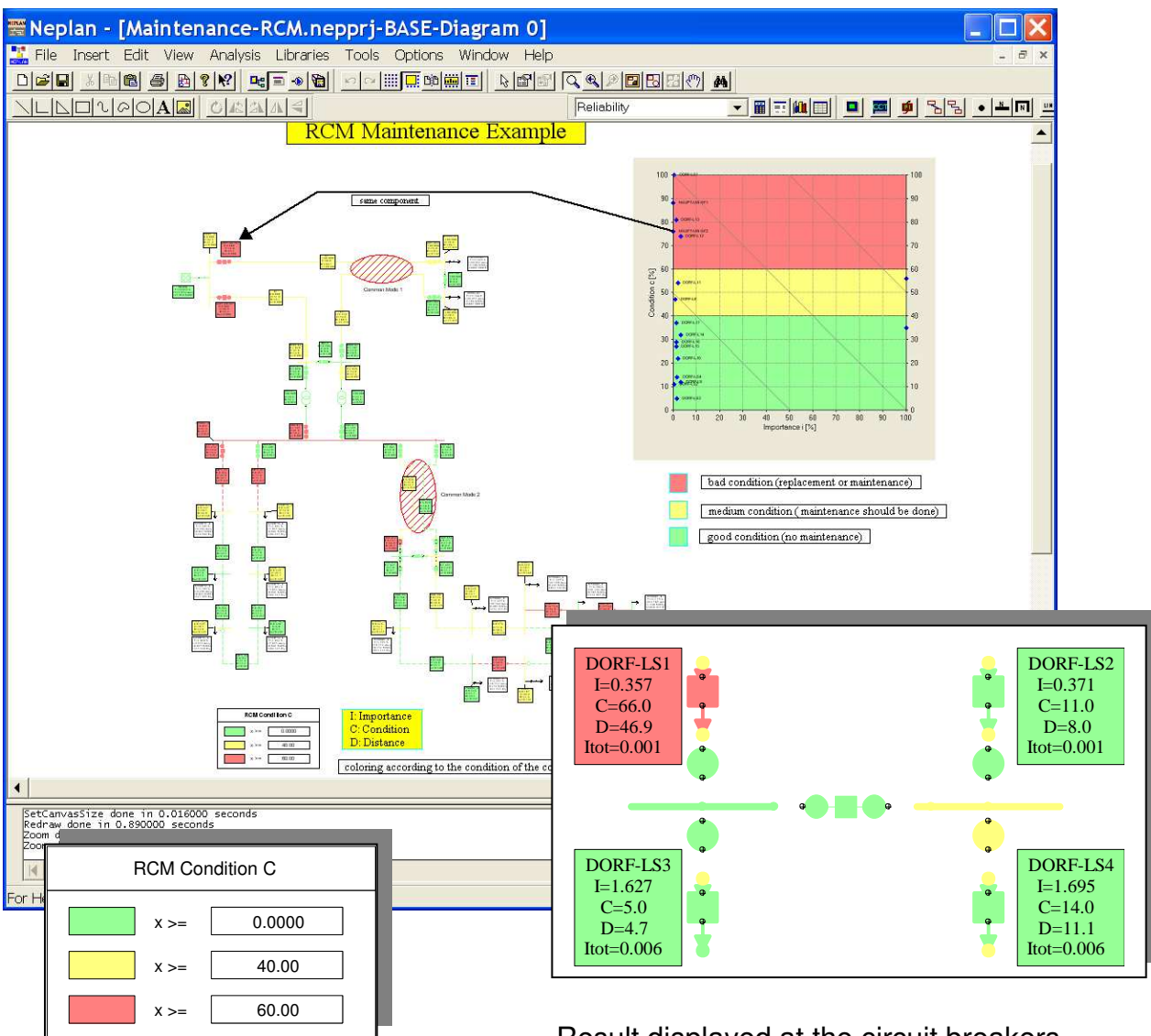

Cable Sizing

Application: Industrial - Generation



Characteristics

- Selection of cable (type, cross section) and protection device for an assumed passive or motor load and a given infeed.
- Cable length is given by the user.
- Cable type is taken from a predefined cable library (pool) within NEPLAN.
- Automatic selection of protection device rating and setting. Device is taken from NEPLAN protection library.
- Sizing of one cable or any number of cables together (distributed radial network)
- Maximum length of selected cable type and section for which the criteria is still fulfilled
- Inspection of already installed cables.

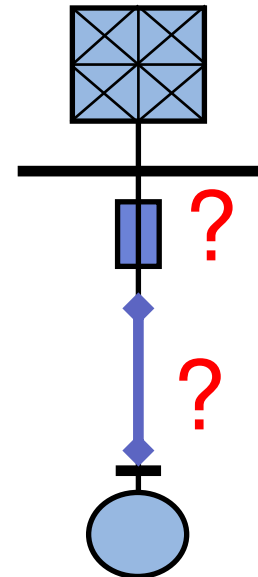

Neplan Library Application - [Line-NYY 4L L]

Type	Unit of	R(1)	X(1)	C(1)	R(0)	X(0)	I _{rmin}
	Length	Ohm/...	Ohm/...	uF/...	Ohm/...	Ohm/...	A
1 NYY 4x 1,5	km	12,1	0,115	0,3915	48,4	0,459	19,5
2 NYY 4x 2,5	km	7,28	0,11	0	29,12	0,441	25
3 NYY 4x 4	km	4,56	0,107	0	18,24	0,426	34
4 NYY 4x 6	km	3,03	0,1	0	12,12	0,403	43
5 NYY 4x 10	km	1,81	0,094	0	7,24	0,378	59
6 NYY 4x 16	km	1,141	0,09	0	4,564	0,358	79
7 NYY 4x 25	km	0,724	0,086	0	2,896	0,355	106
8 NYY 4x 35	km	0,526	0,083	0	2,104	0,314	129
9 NYY 4x 50	km	0,389	0,083	0	1,556	0,312	157

Laying and reduction factor

Laying: in ground

Temper. of vicinity: 25 °C

Heat resistance: 1,5 K*m/W

Laying: multi core, 7cm distance

Laying: in pipe

Number cable trays: 3

Kind of cable: XLPE cable

Max. operating temp.: 90 °C

Degree of loading: 0,85

Number circuits: 4

Single factors: 0,850 0,630 0,850

Total reduction factor: 0,455

Buttons: OK, Reset selections, Cancel

Cable type - general data

Type Name: VPE 10kV EM

Description: Mehrleiter in Erde / XLPE multi core in eart

Conductor material: Cu

Insulation material: VPE - vernetztes Polyethylen

U_r /kV: 10

Laying: in ground

Reference temperature: 20 °C

Max. operating temp.: 90 °C

Max. s/c temperature: 250 °C

S_{thr} / A/mm²: 141

Buttons: OK, Cancel

Criteria of dimensioning

- Service current of consumer, influence current rating of cable
- Protection of cable against overload
- Tolerable voltage drop and voltage limits
- Protection against hazardous voltage (protect persons), influence switch off in tolerable time
- Protection of cable against short-term overheating

Results

Elem.name	distribution	Destination
L-94	46EC03	46HJ03-C
L-95	46EC03	46HJ04-C
L-96	46EC03	46HH04-D
L-97	46EC03	46HK01-C
L-98	46EC03	46HH04-C
L-99	46EC03	46HH01-C
L-100	46CA-B	46XR14N003-A
L-101	46CA-B	46XR14N003-H
L-102	46EC03	46XR13N003-C
L-103	46CA-B	46XR13N003-A
L-104	46CA-A	46XR12N003-H
L-105	46EC03	46XR12N003-C
L-106	46CA-A	46XR12N003-A
L-107	46CA-A	46XR11N003-H
L-108	46EC03	46XR11N003-C
L-109	46CA-A	46XR11N003-A
L-110	46EC03	46XR14N003-C
R-01	46CA-A	46UC40D001
R-02	46CA-B	46UC40D001
R-05	46CA-B	46KE04

Elem.name: L-100
Description:
Starting node: 46CA-B
End node: 46XR14N003-A
I service /A: 0,509427 I start /A: 0,509427
Length /m: 34
Reduction factor: 0,504 Laying...
Tol.volt.drop /%: 3
Tol.volt.drop M5 /%: 12
Overload protection I1 /A: 10
S/C protection I2 /A: 100
tmax /s: 5
Protective Device: B-Automaten
Automat B10
2nd device (s/c): NH-Sicherungen
NH 100 A

Result of Cable Sizing

Overload protection	Iz /A	15,6	<input checked="" type="checkbox"/>	Cable	1 x N2XY 4x1,5
Load flow (normal operation)	line voltage drop du /%	0,20	<input checked="" type="checkbox"/>	Total reduction factor	0,50
	minimum voltage u /%	99,8	<input checked="" type="checkbox"/>	Limited length /m	116
Voltage drop motor start	line voltage drop du /%	0,00	<input type="checkbox"/>	Device	Automat B10
	minimum voltage u /%	0,0	<input type="checkbox"/>	2nd device (s/c)	NH 100 A
	trip time > t /s	0,000	<input type="checkbox"/>	I1 /A	10,0
Protection by disconnection	tmax1 /s	0,016	<input checked="" type="checkbox"/>	I2 /A	100,0
Thermal s/c strength	tmax2 /s	0,775	<input checked="" type="checkbox"/>		

OK

Inspection of Cable Sizing

Overload protection	Iz /A	155.4	<input checked="" type="checkbox"/>
Load flow (normal operation)	line voltage drop du /%	2.35	<input checked="" type="checkbox"/>
	minimum voltage u /%	99.7	<input checked="" type="checkbox"/>
Voltage drop motor start	line voltage drop du /%	1.71	<input checked="" type="checkbox"/>
	minimum voltage u /%	98.0	<input checked="" type="checkbox"/>
	trip time > t /s	> 1000	<input type="checkbox"/>
Protection by disconnection	tmax1 /s	0.027	<input checked="" type="checkbox"/>
Thermal s/c strength	tmax2 /s	0.056	<input checked="" type="checkbox"/>

OK

Characteristics

- Calculation methods IEEE 1584 & NFPA 70E
- Completely integrated and based on NEPLAN short circuit and selectivity analysis modules
- Supports ANSI/IEEE and IEC short circuit calculation for symmetrical and unsymmetrical fault.
- Calculates the incident energy for reduced and unreduced arcing current and in function of the working distance
- Automatically determine the Arcing Fault Clearing Time (reduced and unreduced arcing current)
- Determine individual arcing current contributions
- Individual parameter setting to determine the incident energy
- Automatically assign hazard category for LV (<240 volts) with bolted current less than 10 kA
- Multiple arc flash simulations in one run

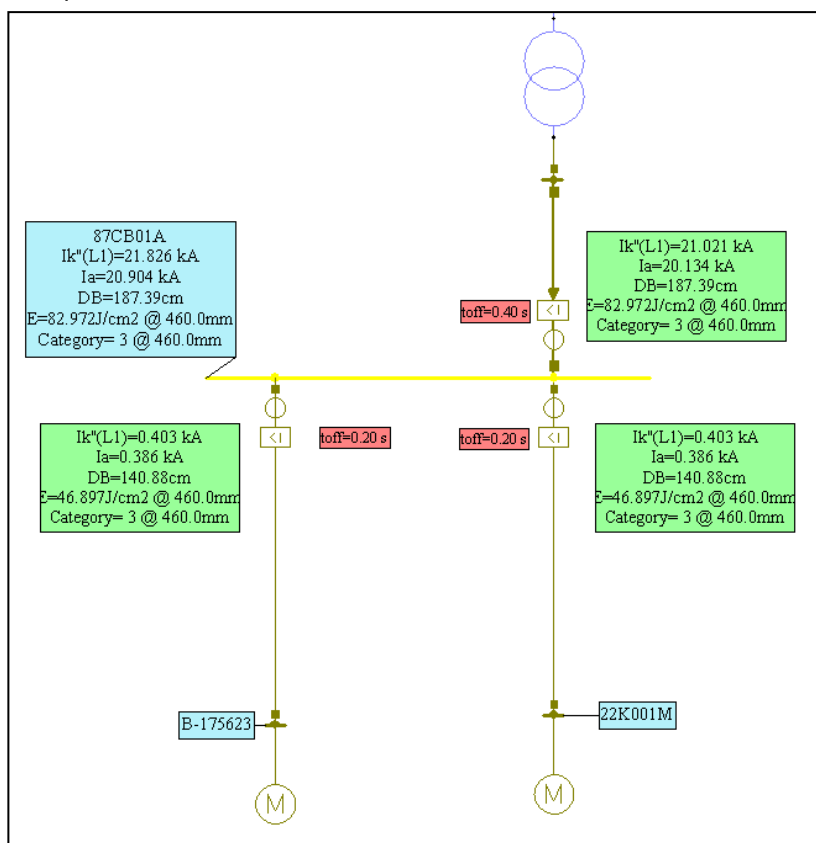
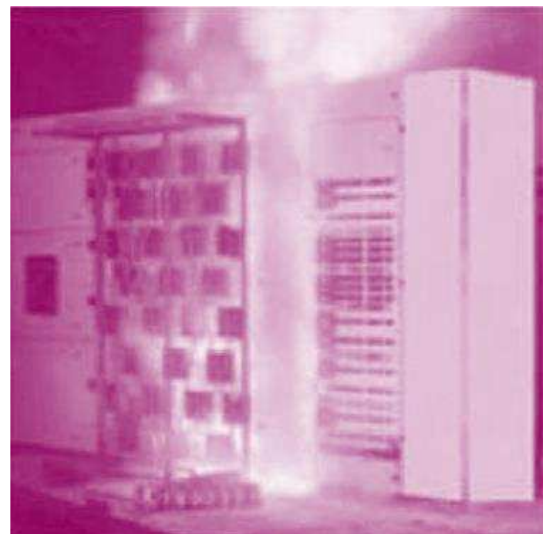

Name	Type	Faulted Node	Un	Ik	Iarc	Iarc reduced	Arc Time	Arc Time reduced	Flash protection boundary	Working distance	Incidence energy unreduced	Incidence energy reduced	Incidence energy decisive	Category
			kV	kA	kA	kA	s	s	cm	mm	J/cm2	J/cm2	J/cm2	
	Node	87CB01A	10.00	21.826	20.904	20.904	0.460	0.460	187.387	460.0	82.972	82.972	82.972	3
										610.0	47.183	47.183	47.183	3
										760.0	30.396	30.396	30.396	2
										910.0	21.201	21.201	21.201	2
K-BT01-US	Line			21.021	20.134	20.134	0.460	0.460	187.387	460.0	82.972	82.972	82.972	3
										610.0	47.183	47.183	47.183	3
										760.0	30.396	30.396	30.396	2
										910.0	21.201	21.201	21.201	2
K-22K001M	Line			0.403	0.386	0.386	0.260	0.260	140.879	460.0	46.897	46.897	46.897	3
										610.0	26.669	26.669	26.669	2
										760.0	17.181	17.181	17.181	2
										910.0	11.983	11.983	11.983	1
L-175616	Line			0.403	0.386	0.386	0.260	0.260	140.879	460.0	46.897	46.897	46.897	3
										610.0	26.669	26.669	26.669	2
										760.0	17.181	17.181	17.181	2
										910.0	11.983	11.983	11.983	1

General Characteristics

- Control variables: active / reactive power generation, schedule voltages of generators and taps of ULTC-transformers, reference values of HVDC systems and FACTS (UPFC, STATCOM, SVC, TCSC)
- Variable limits for bus voltages, branch loadings, active and reactive power of generators
- Individual or general limits, 'consider/not consider' limits function
- Objective function: apply to whole network / to a certain area or zone, minimize / maximize MW losses, Mvar losses, generation cost, MW import or Mvar import, MW Interface flow
- Multi objective function is possible (use of weighting factors)
- Security constrained optimization (with n-1 contingency constraints)

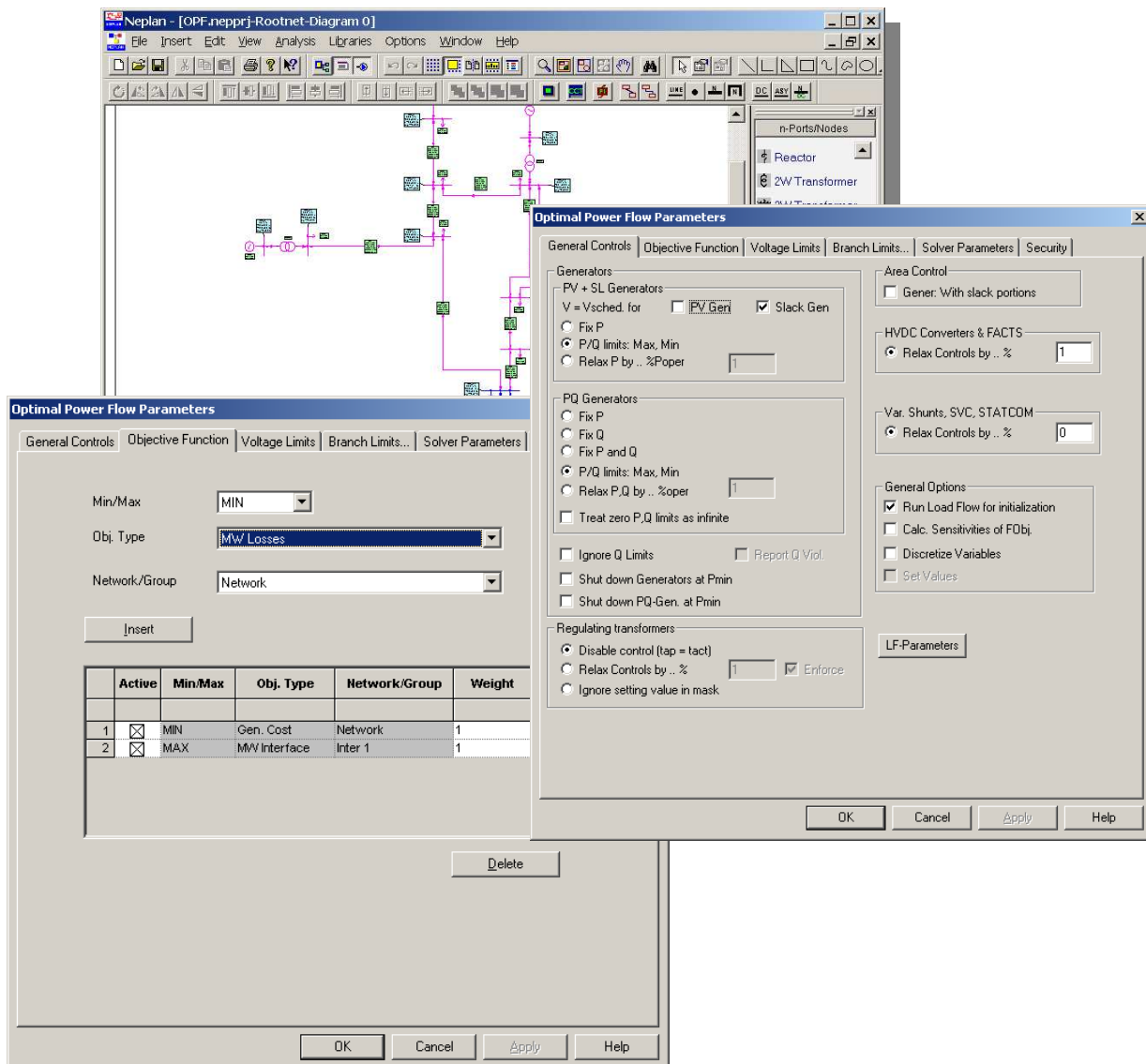

Results

- Automatic display of results.
- Optimization results (binding constraints, variables at limits, lambda multipliers, sensitivities, network controls, coloring of limiting network elements in the graphic)
- 'Move' and 'Delete' function for result boxes.
- Self-defined result output: the user can select items, units, font, precision, placement.
- Overloaded elements or nodes with voltages outside predefined limits are highlighted.
- Line thickness corresponds to element loading.
- Results can be saved in a text file (ASCII)
- Table output: for the whole network, individually for each area / zone. Listing of power flows between area/zones, overloaded elements, sorting function, selective output.
- Table interface with MS-Excel

The screenshot displays the NEPLAN software interface during an Optimal Power Flow (OPF) analysis. On the left, the 'OPF Results' dialog box is open, showing options to display variables at limits, binding constraints, and network controls. It also includes a 'Color Variables at limit' section with checkboxes for 'Control Variables' and 'State Variables', and buttons for 'Show With OPF Coloring' and 'Undo OPF Coloring'. The main window shows a network diagram with nodes and lines. A table below the diagram provides a summary of results, and a larger table at the bottom shows detailed 'Element Results'.

To	P Loss	Q Loss	P Imp	Q Imp	P Gen	Q Gen	P Load	Q Load	Qc S
Area/Zone	MW	MVar	MW	MVar	MW	MVar	MW	MVar	M
	7.554	-274.595	59.02	-3.094	808.554	190.405	801	465	0
	3.766	-156.221	65.551	17.186	444.215	126.593	506	300	0

ID	Name	U	u	U ang	P Load	Q Load	P Gen	Q Gen	Q Shunt
		kV	%	°	MW	MVar	MW	MVar	MVar
25	NO_1	20.4	102	5.3	0	0	284.218	66.301	0
9	NO_10	215.026	97.74	-7.1	60	30	0	0	0

ID	Node	Element	Type	P	Q	I	Angle	Loa
	name	name		MW	Mvar	kA	°	
12	149	NO_12	EL13	-20.855	-11.491	0.064	142.9	0
13	153	NO_12	EL14	28.776	7.593	0.08	-23.1	0
14	157	NO_12	EL15	28.776	7.593	0.08	-23.1	0
15	413	NO_12	LO_12	8	2	0.022	-22.3	0
16	141	NO_13	EL11	-60.749	-13.557	0.166	159.9	0
17	145	NO_13	EL12	44.749	3.557	0.12	-12.1	0
18	404	NO_13	LO_13	16	10	0.05	-39.5	0
19	133	NO_14	EL9	-49.603	-12.825	0.134	162.7	0
20	137	NO_14	EL10	-49.603	-12.825	0.134	162.7	0
21	141	NO_14	EL11	61.205	5.651	0.16	-8.1	0
22	403	NO_14	LO_14	38	20	0.112	-30.6	0

Small Signal Stability

Application: Transmission



The NEPLAN Small Signal Stability module provides eigenvalue analysis (modal analysis) for electrical power systems. It combines exceptional ease of use with the latest techniques and standards in both electrical power engineering and software design.

Applications

- Analysis of interarea oscillations
- Analysis of interplant oscillation
- Analysis of subsynchronous oscillations/resonance (SSR)
- Identification of groups and subgroups of machines swinging against each other
- Determination and improvement of power oscillation damping
- Design and placement of control equipment, such as power system stabilizers
- PSS tuning

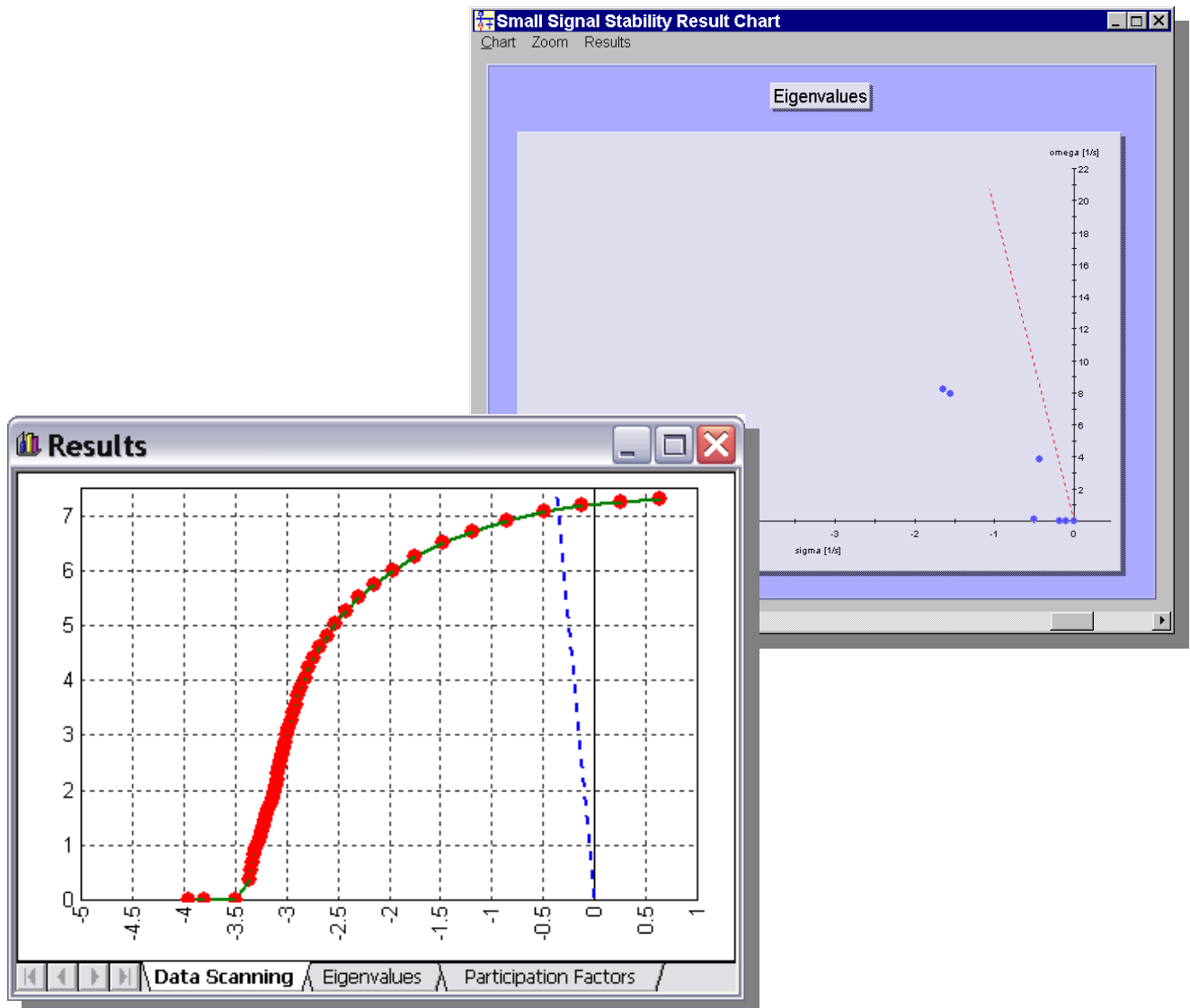

Main Features

- Data scanning and eigenvalue sensitivity functions
- Automatic construction of the linearized state space notation for the complete system, including generators, static loads, control circuits, etc.
- Advanced synchronous machine modeling: choose for every synchronous machine one of the five models infinite, classical, transient, subtransient and general. Saturation curves for both, d-axis and q-axis.
- Automatic calculation of eigenvalues, eigenvectors, mode shapes, participation factors for eigenvalues and state variables.
- Text results: results are presented in clear form and can be customized by several output options.
- Graphical results: results can be visualized by the fully integrated graphical results manager. Charts can be easily printed and exported to external programs (e.g. Microsoft Word) by clipboard functions. A variety of chart options is available.
- The only requirement is the NEPLAN load flow module. However, the Small Signal Stability and the Transient Stability (Dynamic Simulation) module of NEPLAN complement each other ideally.
- The Small Signal Stability module is completely integrated in NEPLAN and uses standard dynamic element data.

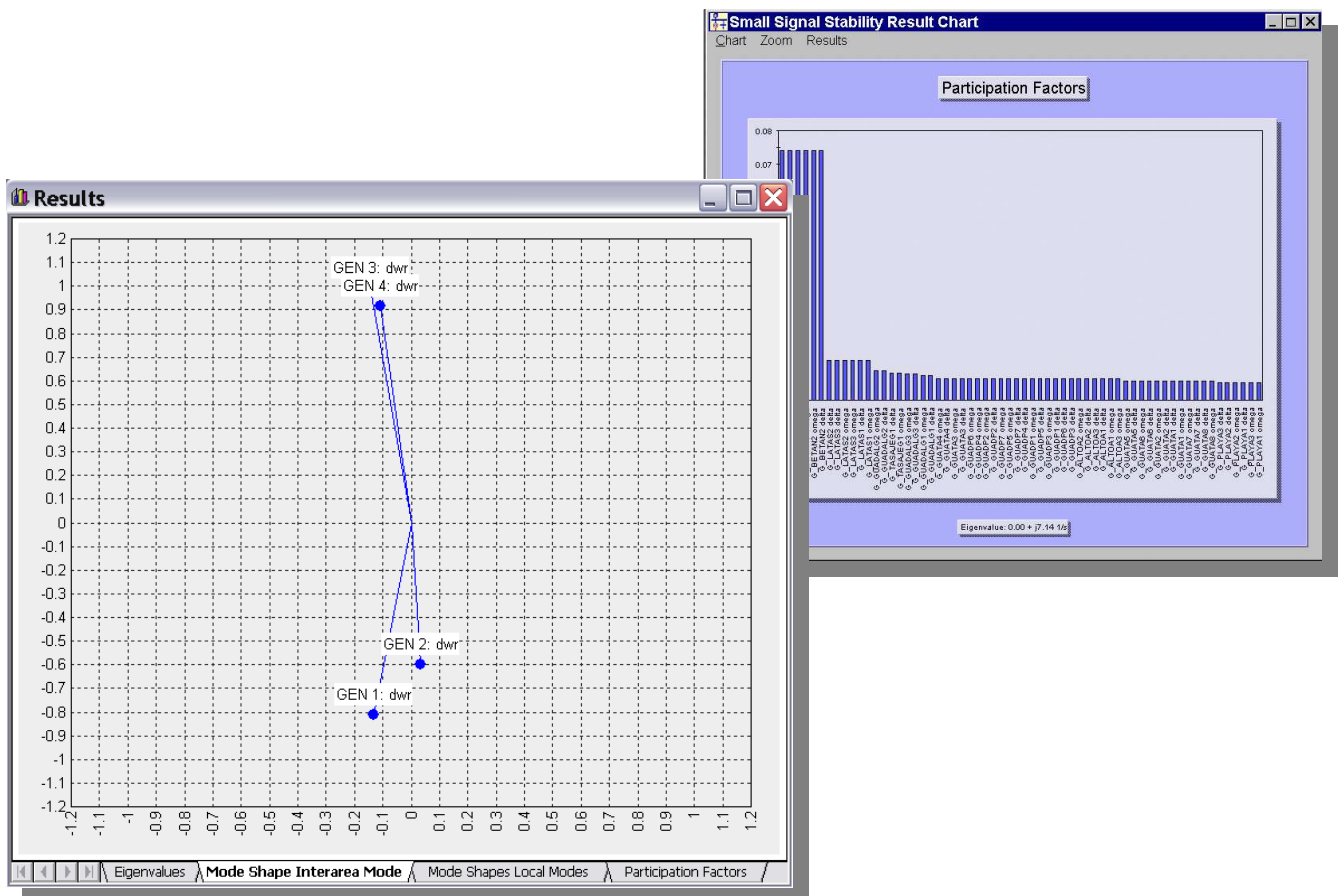

Voltage Stability Analysis

Application: Transmission



As an integral part of NEPLAN software, the Voltage Stability module provides four approaches for static voltage stability analysis of power systems: **V-Q curves**, **P-V curves**, **V-Q sensitivity analysis** and **Q-V eigenvalue analysis (modal analysis)**. This module allows examination of a wide range of system conditions. It is an ideal tool to provide much insight into the nature of voltage stability problems.

Applications

- Identification of weak / not controllable / unstable areas
- Identification of weak and heavily loaded links
- Proper distribution of reactive reserves in order to maintain an adequate voltage stability margin
- Voltage sensitivity information
- Degree of voltage stability
- Most effective measures in improving voltage stability

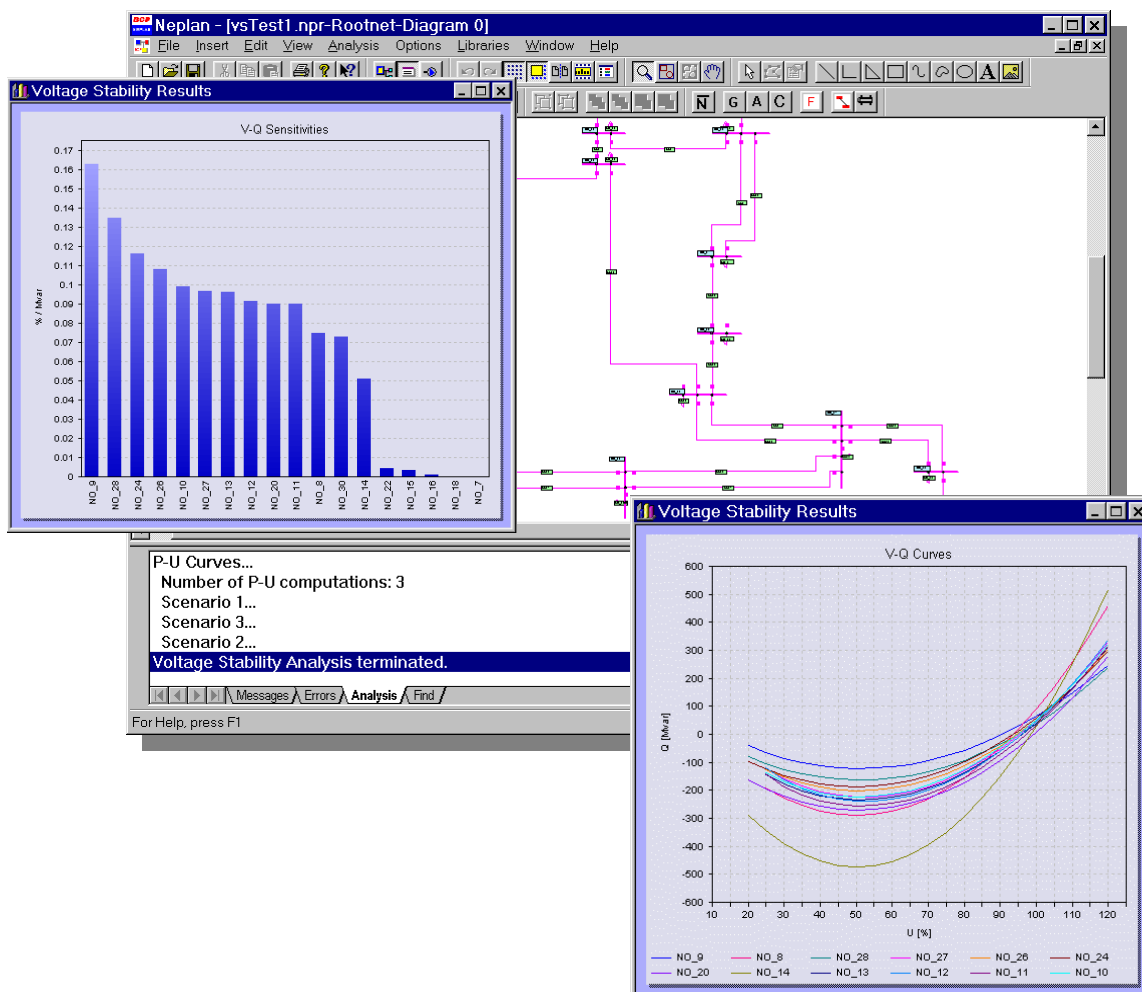

Voltage Stability Analysis

Application: Transmission



Main Features

- Automatic calculation of P-V curves, V-Q curves, dV/dQ self-sensitivities, dV/dQ mutual sensitivities, eigenvalues, eigenvectors, bus participation factors, branch participation factors and generator participation factors.
- Result tables: results are presented in clear form and can be exported by Copy-Paste-methods to external programs (e.g. MS-Excel).
- Graphical results: results can be visualized by the fully integrated graphical results manager.
- Export files: results are stored in text files for advanced data export.
- Charts can be easily printed and exported to external programs (e.g. MS-Word) by clipboard functions. A variety of chart options is available.
- Input: standard load flow input data

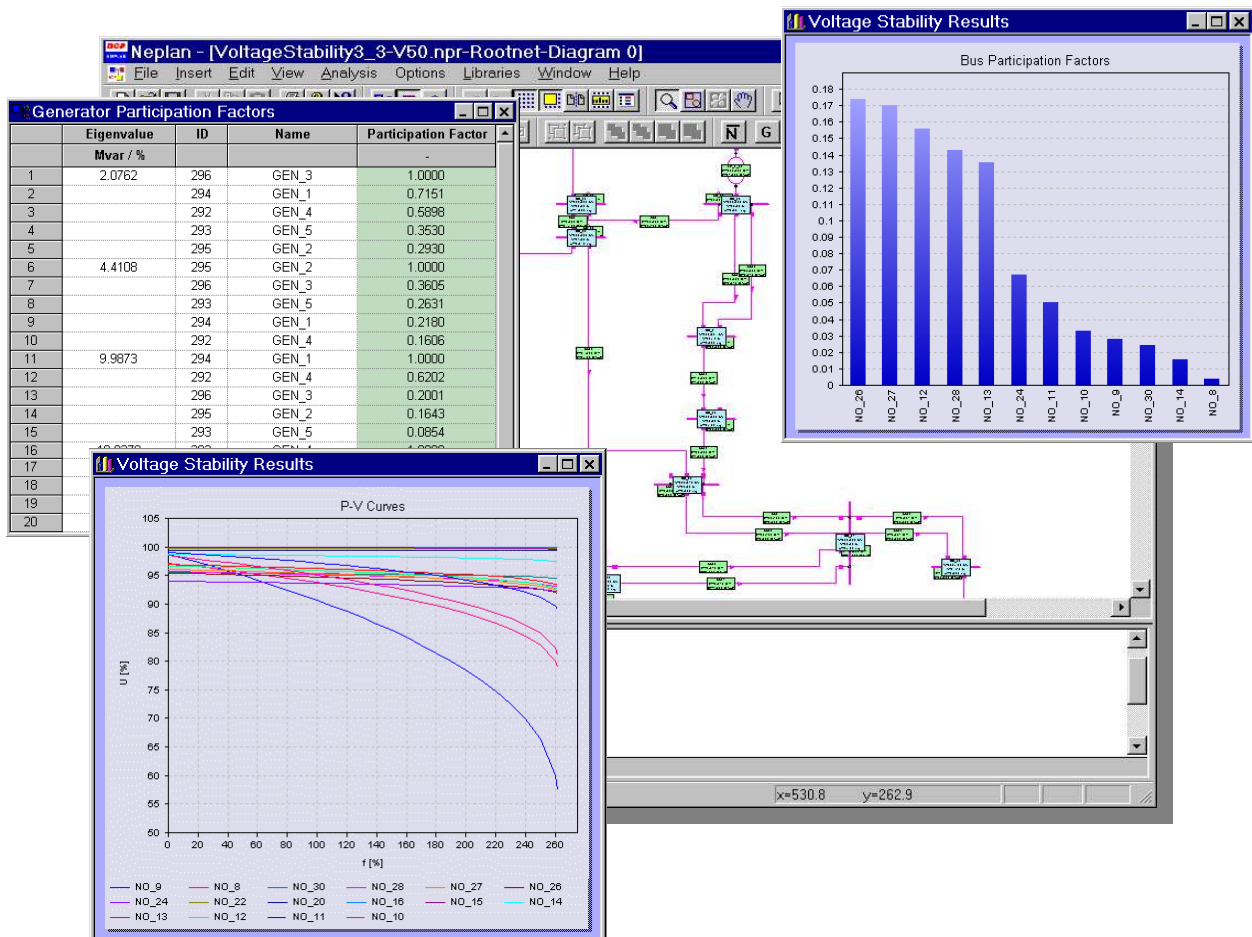

Available Transfer Capability Analysis (ATC)

Application: Transmission



Features

- Calculation of max. MW transfer between regions
- ETSO methodology (load flow based, MW generation shift)
- Large flexibility in limit handling (individual activation of limits)
- Consideration of user-defined contingency scenarios
- Consideration of TRM (Transmission Reliability Margin)

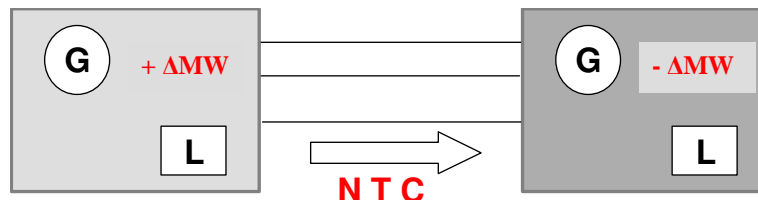
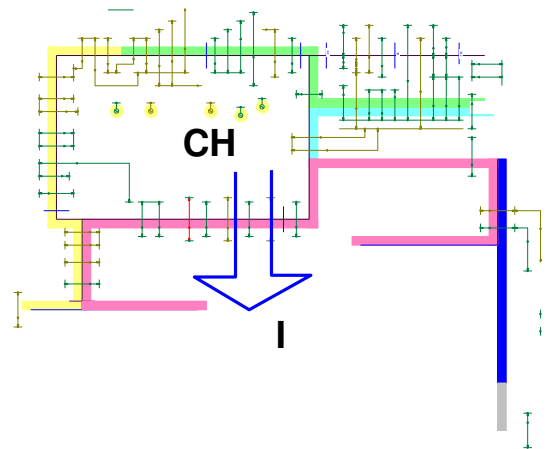

Generation shift from source to sink

Results

Report for every step of MW transfer on:

- Limit violations for base case
- Limit violations for each contingency case
- Calculation of TTC (Total transfer capacity) and NTC (Net transfer capacity)

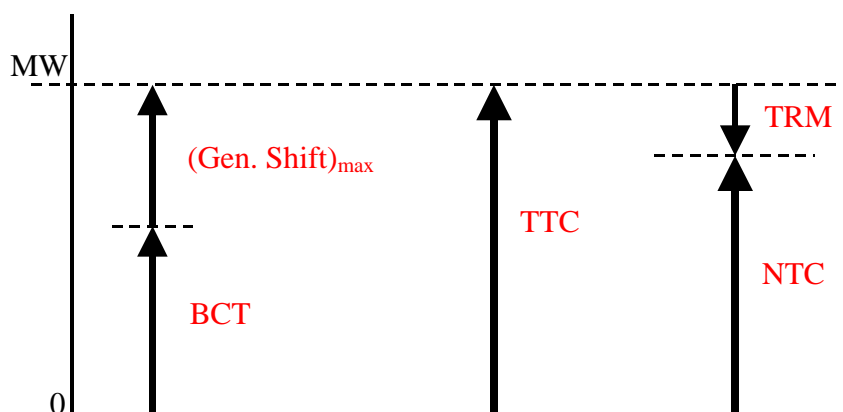

Day-Ahead Congestion Forecast (DACF)

Application: Transmission



Build UCTE files for different topology and loading network scenarios (cases). It can be used for importing UCTE files, running load flows for every hour of the next day and storing the load flow results in UCTE format or as a NEPLAN project.

Features

- Import UCTE-formatted network data (own network, partner network data)
- Use of reference network data in case of missing partner files
- Check for errors and consistency of imported UCTE files
- Import topology and loading data for each hour of the next day
- Use of map files in order to export only certain HV nodes and lines from the detailed network model
- EASY HANDLING! All information is stored in the project, so that the overhead of restarting DACF computation each day is minimal.

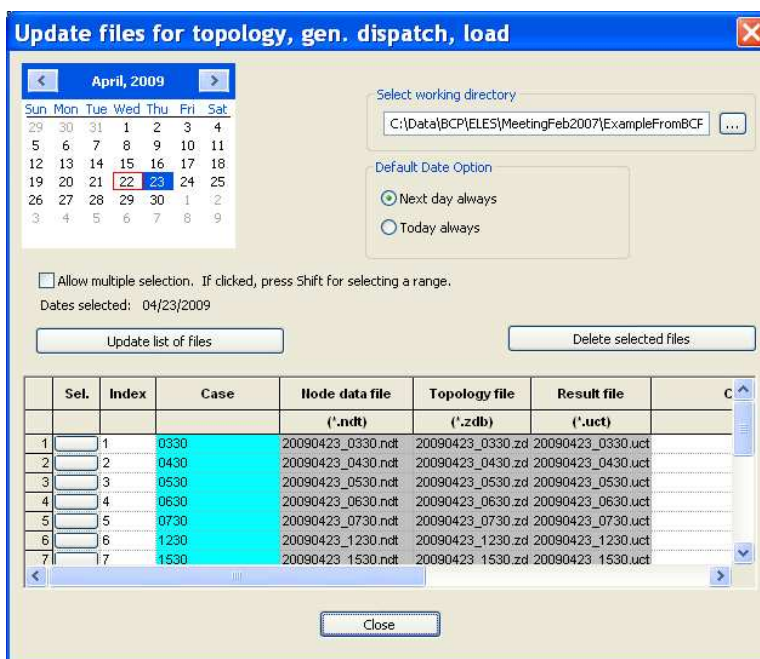
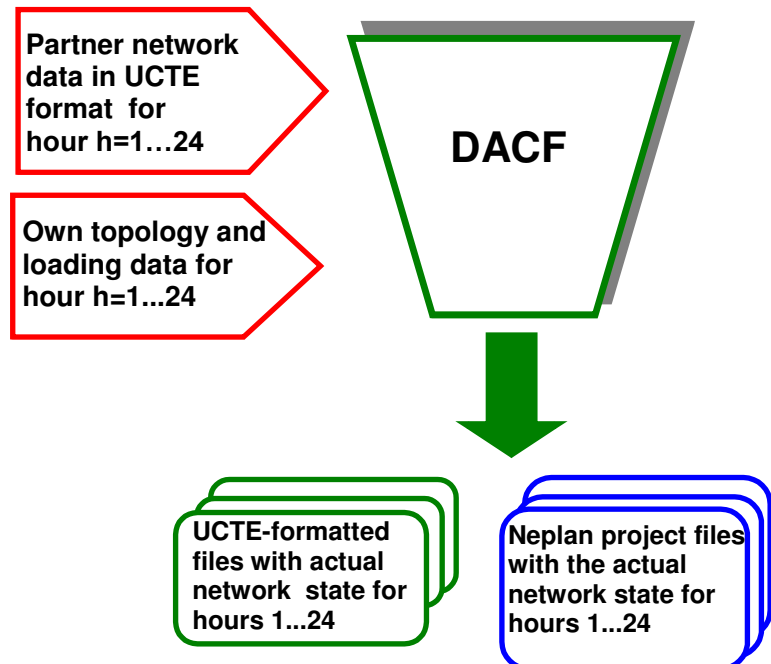

Results

- Export UCTE-formatted data for own network for each hour of the next day. Each file corresponds to the load flow solution for the actual loading and topology state of that hour.
- Create a network model (NEPLAN nepprj file) for each hour of the next day. The user can edit and work on each NEPLAN file directly.

NEPLAN® - Consulting

BCP Busarello + Cott + Partner is part of the international NEPLAN®-Consulting group. The NEPLAN®-Consulting group offers a wide range of power system studies and consultancies. More than 1000 projects all over the world have already been successfully realized. The NEPLAN®-Consulting group conducts studies to evaluate energy markets, solve electric system design, planning and operations related problems, perform system engineering, and provide equipment application expertise. We help you to optimize the value of your energy assets and transactions, and to better design, plan and operate your transmission, distribution, industrial systems, and/or merchant plant integration projects.

Our services include:

Merchant Project Siting

- *Energy locational marginal price analysis*
- *Capacity value assessment*
- *Value of ancillary services*
- *Forward price discovery*
- *Transmission constraint evaluations*
- *Value of transmission congestion relief*

Market and Individual Asset Evaluation

- *Valuation of generating and transmission assets*
- *Market risk assessment, profit and lost potentials*
- *Project due diligence activities*
- *Physical transmission access capability*

Feasibility/System Impact/Facility Upgrading

- *Load flow, contingency, short circuit, and stability analysis for the interconnection of merchant projects*
- *Interconnection configuration and conceptual designs*
- *System reinforcement option and cost assessment*

Transmission Capability Analysis

- *Transmission constraint identification and mitigation*
- *Simultaneous transfer limit calculations*
- *ATC calculation with consideration of TRM/CBM*

System Dynamics and Control

- *Transient and dynamic stability analysis*
- *Control tuning, design, and interactions*
- *SSR, SSTI, transient torque, torsional interaction*
- *Voltage instability*

Transient Analysis and Insulation Coordination

- *Arrester rating, energy requirements and location*
- *Switching transients, equipment BIL, BSL*
- *Phase-to-ground & phase-to-phase clearances*
- *Contamination performance*
- *Circuit breaker recovery voltage*

Harmonic Analysis

- *Harmonic filter design, filter performance and rating*
- *AC/DC harmonic filters, including active filters*
- *Network harmonic flow*

Distribution System Planning

- *Budget constrained planning*
- *Two-Q (Quality & Quantity) Engineering*
- *Distribution network evaluation*
- *Distributed resource interconnection*

Reliability

- *Probabilistic system planning*
- *T&D system reliability evaluation*
- *Substation RAM studies*
- *Integrated generation and transmission planning*
- *Failure mode, effect, fault tree analysis*

Protective Relaying and Controls

- *Protective system design and relay coordination*
- *Adaptive relaying, fault location*
- *Phasor estimation, power quality, high impedance fault detection*
- *Integration of protection, control and monitoring*
- *Wide-area disturbance protection and control*

HVDC

- *AC/DC interactions, and planning*
- *Conversion of AC lines to DC*
- *Dynamic performance & control requirements*
- *AC/DC filter design*
- *Reactive power requirements*
- *Equipment specification*

Flexible AC Transmission (FACTS)

- *Planning: location, type and size*
- *Dynamic performance & control requirements*
- *Control design, interactions*
- *Static VAR systems: SVC, GTO-based SVC*

Wind Energy

- *Stability aspects in power system and wind park*
- *Determination of optimal connections in regard of technical and economical aspects*

Education & Training

- *Short 3-5 day courses, regional or at customer site*
- *1 day NEPLAN introduction*

NEPLAN®

Smarter Tools

Planning and optimization system for gas, water and district heating networks



Successfully applied all over the world

NEPLAN Power System Analysis - one of the most complete planning, optimization and simulation tool for electrical, gas, water and district heating networks

Reliable – Efficient – User-friendly

Data management

- All equipment and pipes can be entered graphically and/or table oriented (like in a excel sheet)
- A single line diagram can easily be generated through a very user friendly CAD system.
- There is no restriction on drawing sizes and number of nodes and elements.
- Extensive editing functions like undo, redo, delete, copy, move and zoom for manipulating the network single line diagram are available. A pipe can be moved from a node to a different node without deleting the pipe.
- OLE functionality: Data and graphic can be moved to and from third party software (like MS-Excel, MS-Word). Project documentation has never been easier.
- The element data are entered through dialogs including plausibility of the entered data. A coloring tool helps to show which data fields of the dialog are needed for a certain analysis (e.g. time simulation).
- Integrated Variant Manager (insert, delete, append, compare variants, compare results, etc.).
- ASCII file or SQL database oriented import/export functions for exchanging network data, topology data, load data and single line data are available. That means all data including the graphical data are accessible by the user.
- Interfaces to external programs (e.g. measured data acquisition systems) can be implemented.
- Import of a geographic map as a background graphic, for easier schematic capturing.
- Import of almost any raster and vector graphic files (e.g. PCX and DXF files).
- Graphics can be exported as raster files (e.g. JPG, which can be used in any internet web browser).
- Option for combining and separating networks. Any number of independent network areas and zones are possible. Each element and node may belong to any independent area and zone.
- Extensive functions for network statistics and network documentations are available.
- A state of the art library manager with extensive libraries for each element type facilitates data entry.
- All computation modules access a shared database.
- Integrated chart manager allows analyzing and comparing all results from different variants.
- NEPLAN is available in different languages (e.g. English, French, Spanish, German)

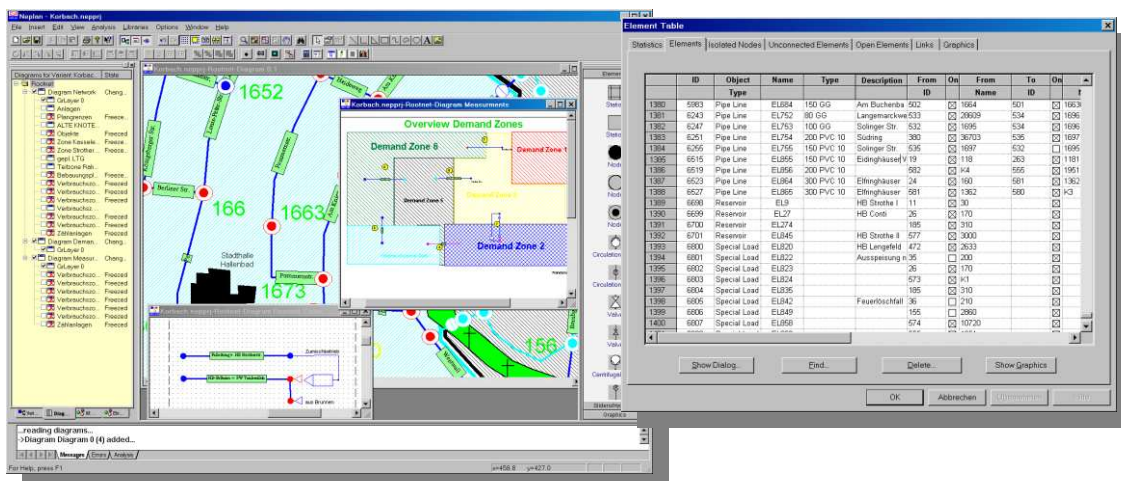

Variant Management

- Non-redundant storage and management of variants.
- For each network, you may select
 - * any desired switch states (topology file)
 - * any desired loading states (loading file)
- For each network you can define and store any desired number of variants and sub variants (variant tree). Only the differences from the parent variant are stored in the project.
- Variants can be compared, merged and deleted.
- The diagrams of different projects and variants can be displayed at the same time
- Results from two different variants can be displayed on the diagram in one result label.
- Results of two variants can be compared in the chart manager.

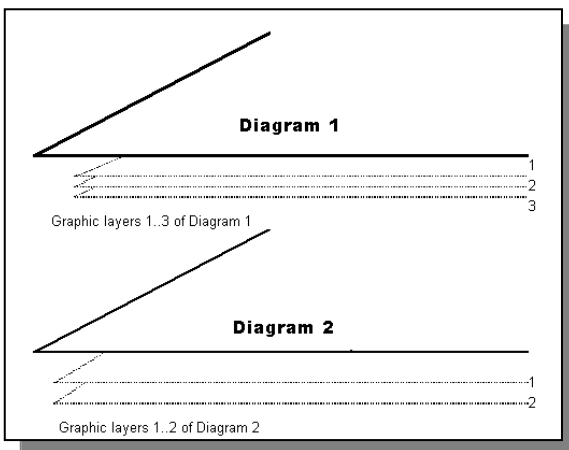
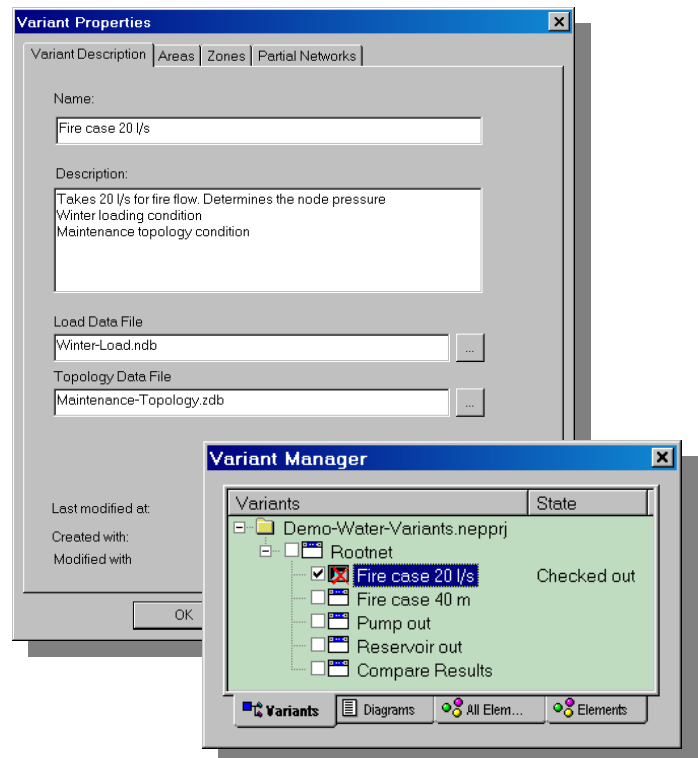

Multi-Diagram and Multi-Layer-Technique

- A network (project) can be entered in several different diagrams (e.g. the high pressure network in one diagram and the low pressure networks in one or more other diagrams).
- Each diagram can have any number of graphic layers. These layers can be colored, locked, hidden or shown (like for example in AutoCAD).
- Zooming into pump stations: in the overview diagram, a station is shown as a black box, while in another diagram it is depicted in detail, with all its equipments.
- Display the main equipments in a separate diagram, to have quick overview of the whole network without zooming around in the big single line diagram.
- Topological linkage of elements over more than one diagram.
- One element can have more than one graphical representation in the same diagram or in different diagrams.
- OLE. Copy/Paste graphic data from and to MS-Word.

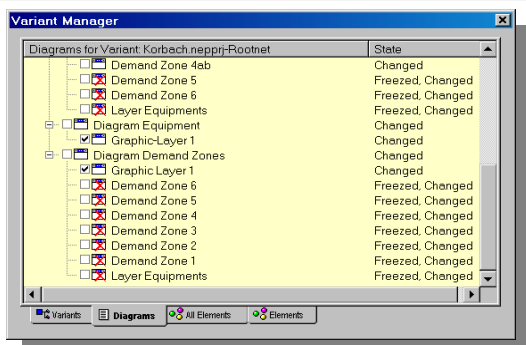

Auxiliary Graphics

- Auxiliary graphics can be used for documenting the diagram. There is no need to export the single line diagram to another CAD system.
- Input of lines, rectangles, ellipses, arcs, ellipse sections, polygons, poly-lines, any kind of bitmap graphics.
- Input of user text with selectable character set.
- Color for background, foreground, line, outlines and fill patterns is user-selectable.
- Functions available for rendering overlapped symbol elements, rendering, alignment and rotation

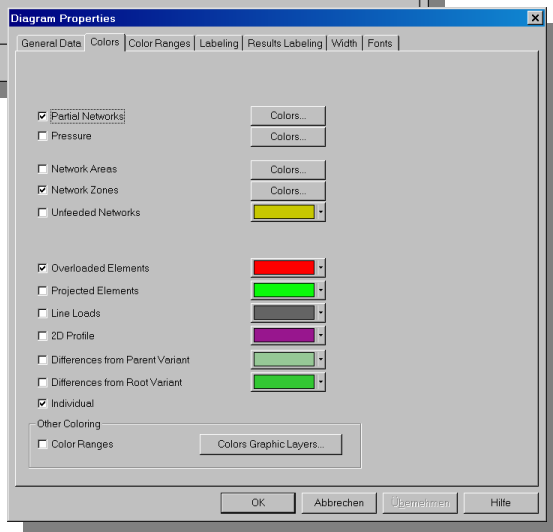
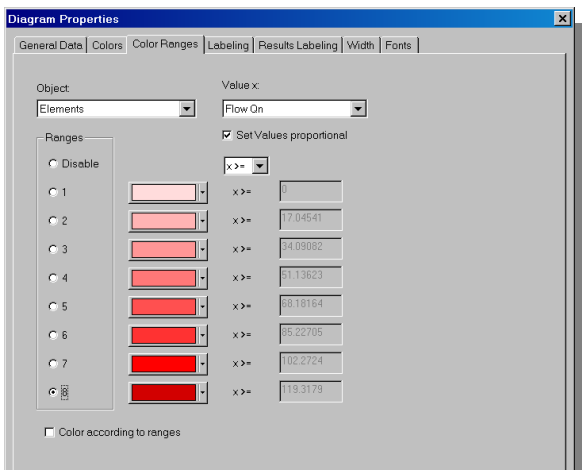
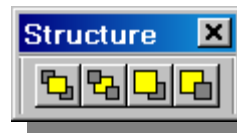
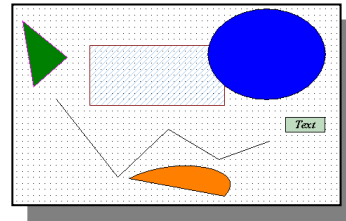

Network Diagram Coloring

- Colors and line types can be freely selected.
- Overloaded elements (e.g. $v \text{ m/s} > v_{\text{max}} \text{ m/s}$) after a calculation are color-highlighted.
- Isolated elements can be highlighted.
- Coloring options to distinguish user-selectable network areas and zones, pressure zones, not fedded networks and separated partial networks.
- Differences to the parent variant or the root net can be colored.
- Each element can be colored individually.
- User defined graphic layers can be colored.
- Coloring according to ranges. Many calculated variables can be colored according to their values (e.g. according to velocities ($v \text{ m/s}$) or according to pressure drops)



Symbol-Editor

- The user can create and define its own symbols for all elements.
- Any number of different symbols per element type or node can be defined.
- All symbols will be displayed while entering the diagram. Just drag and drop the desired symbol to the diagram
- On the diagram the symbols can be flipped, rotated and resized.

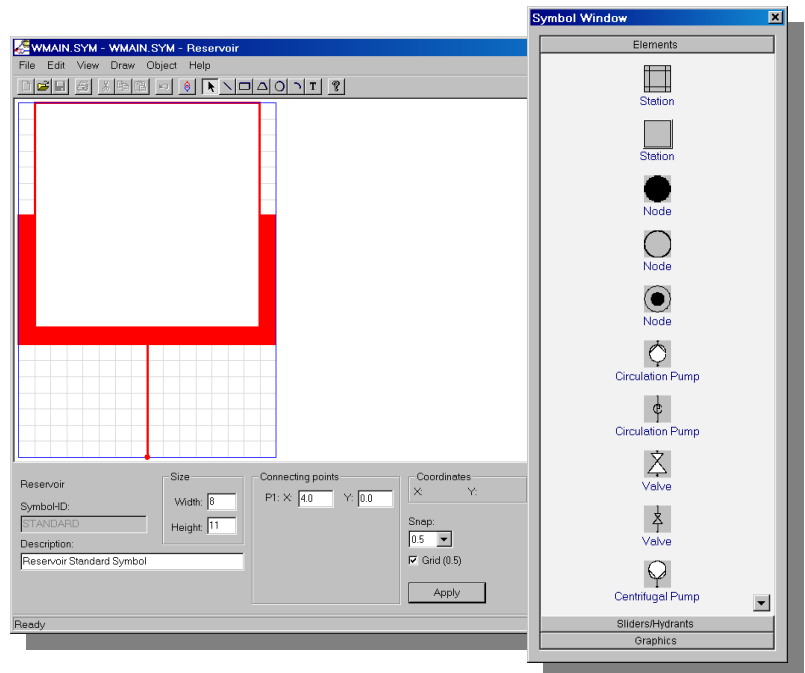

SQL Database Connection

- All element data can be imported and exported to any SQL database (like Oracle, MS-Access, etc.)
- The network topology can be stored.
- All graphical data of the elements and nodes can be exported and imported.
- All data of all libraries can be imported and exported.
- Can be used as interface to existing GIS and NIS or DMS/SCADA systems.
- Very flexible storing and import features, like full import or only partial update, storing only the differences of a variant.
- Partial reading of data fields (e.g. import only the pipe length but not the diameter and roughness).
- The database can be simply upgraded to form a NIS using the database functions.

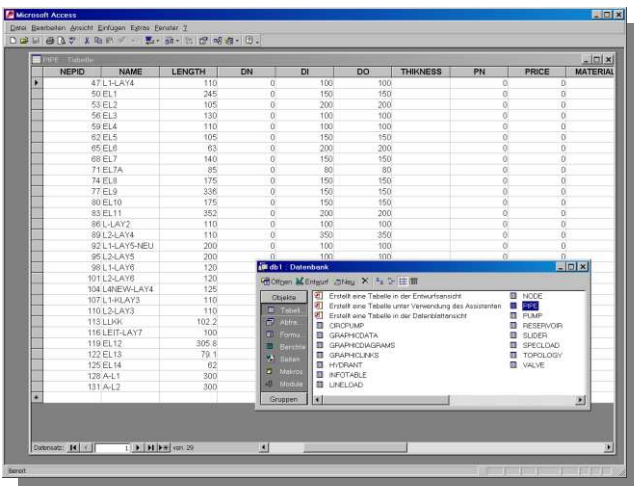



Library Manager

- A comprehensive library manager is available in NEPLAN.
- For each equipment type a library exists or can be created by the user.
- While entering network data the library data can be accessed. Further more the data entered in the network, can be exported to the library.
- All network data can be updated with changed library data.
- The data can be entered through excel like table sheets.
- Import/export to MS-Excel with drag and drop.
- Import/export to any SQL database. Update functionality from/ to database is provided.
- Part of diagrams with all technical data can be stored in the library.

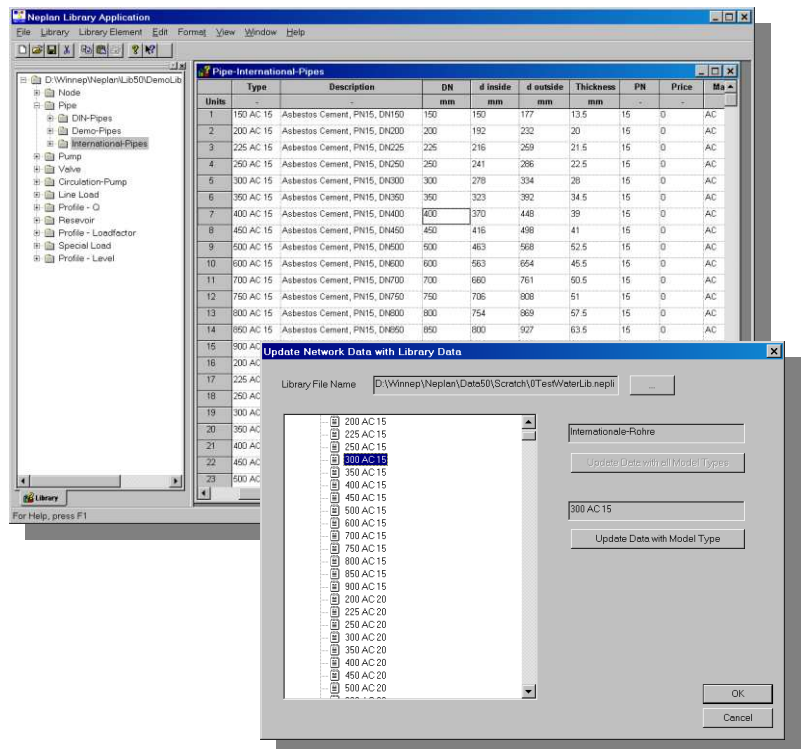
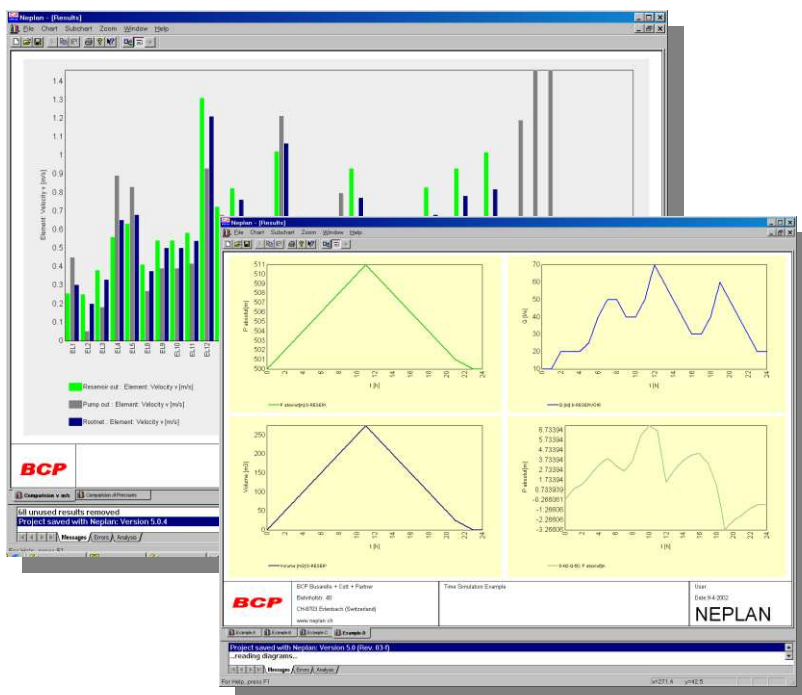
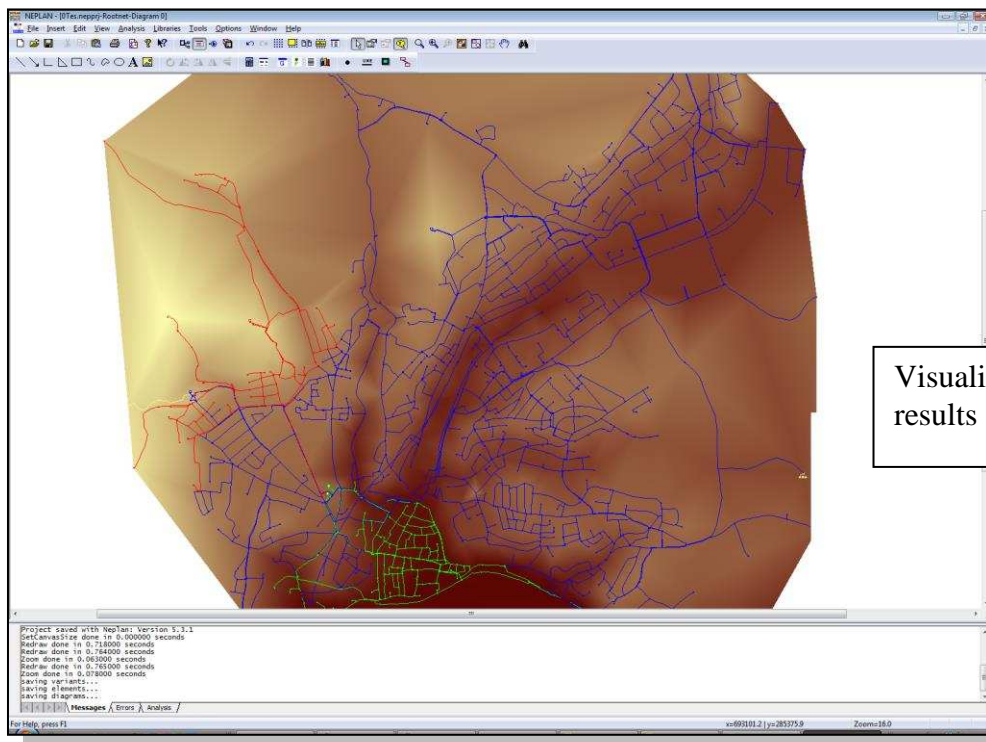
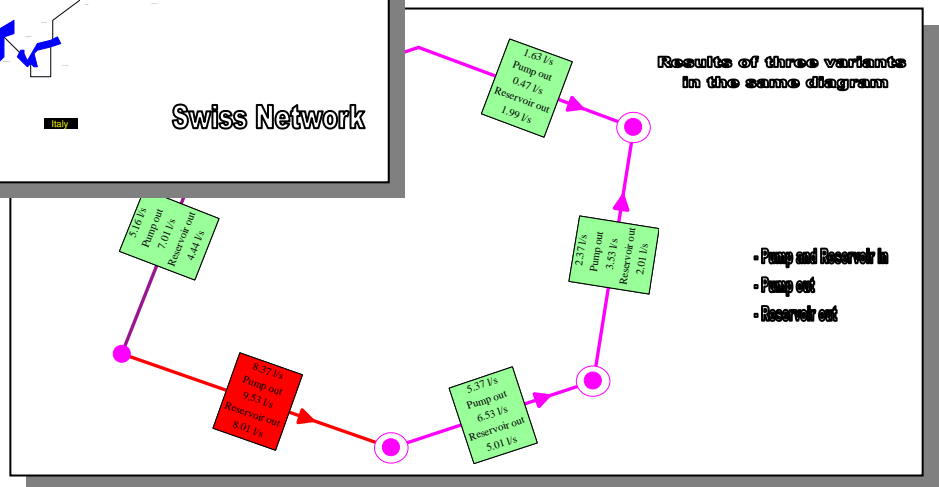
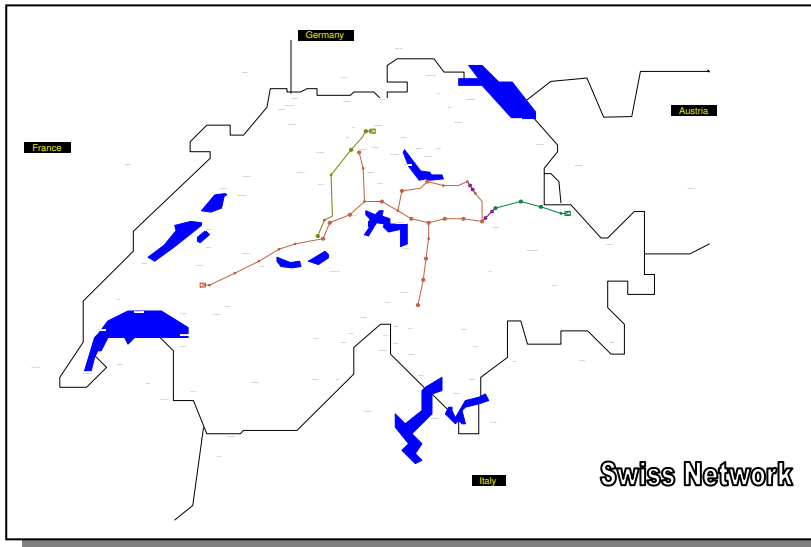

Chart Manager

- The chart manager allows displaying the results in different chart types (e.g. line, bar, etc.).
- Any number of sub charts can be displayed in one chart.
- A user defined logo (as bitmap) can be added to the header for documentation purposes
- Results from different variants can be compared and displayed in the same chart.
- Export the chart to *.JPG file for any internet browser.
- Copy/Paste to the clipboard for documentation (e.g. MS-Word).





EQUIPMENT-OVERVIEW

HB Erlheim

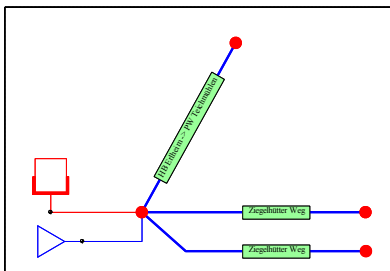

HB Conti

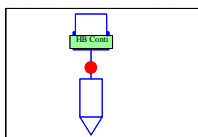

PW Teichmühle

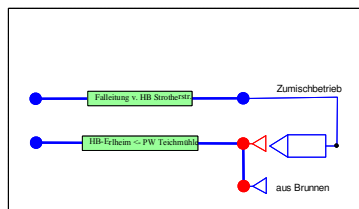

PW Eidinghausen

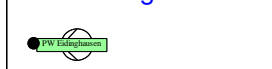

PW Paeddemarke



DEA Höhl

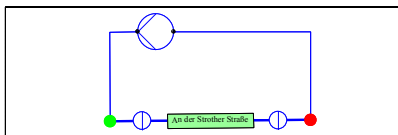

DEA Kasseler Str.

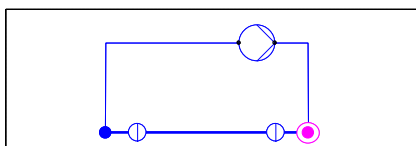

HB Strother Str.

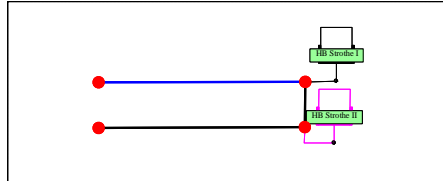
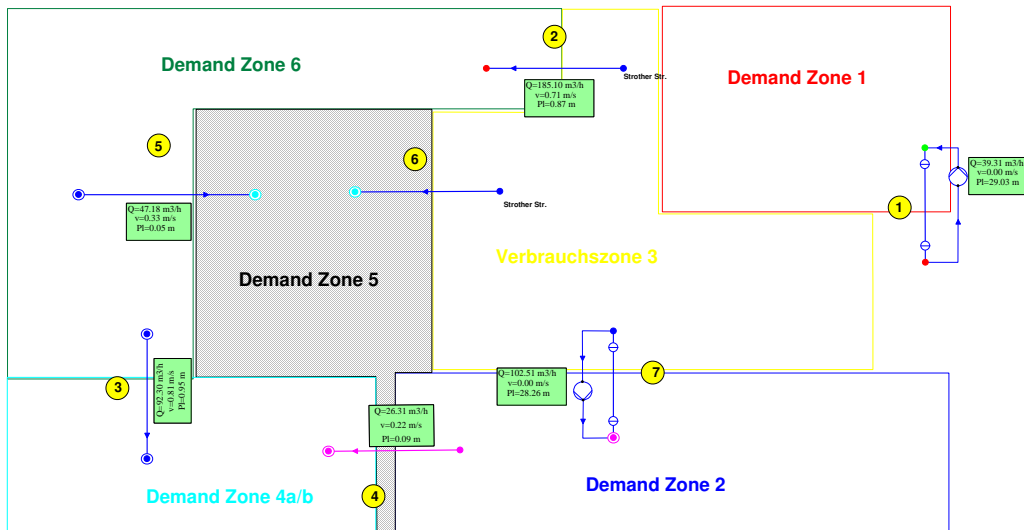

Diagram Equipment

Overview Demand Zones



Designed by Gelsenwasser AG

Diagram Measurements

Zone/Area interchange

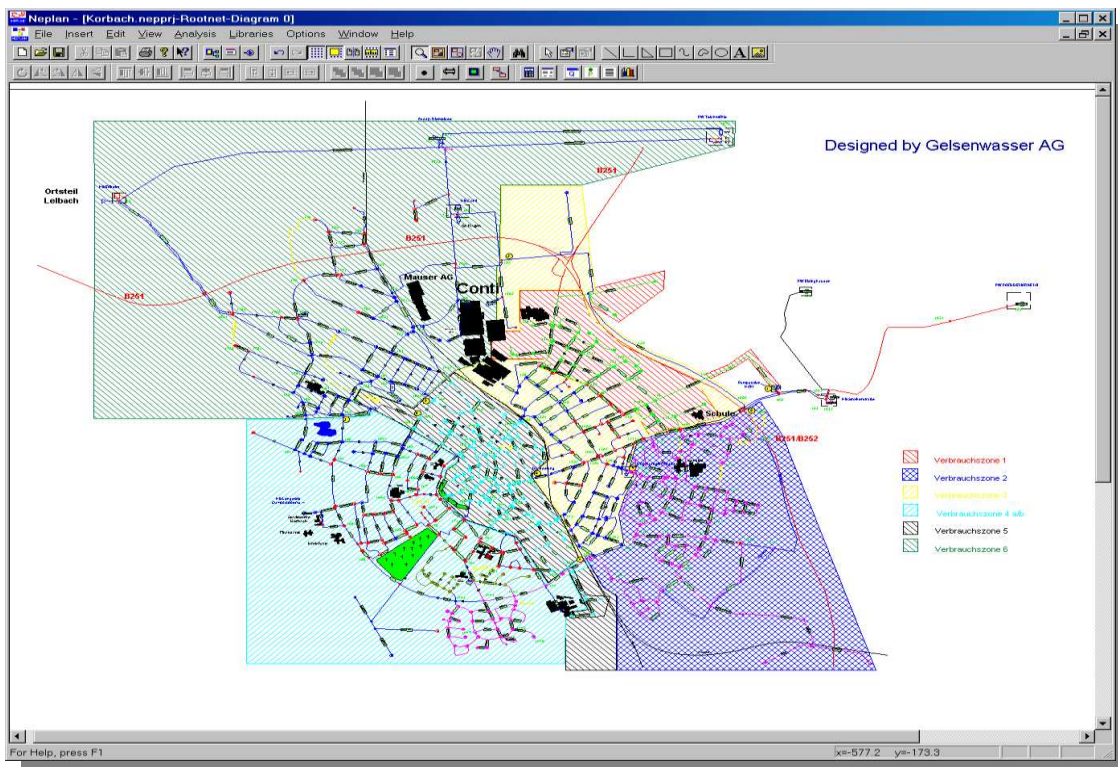
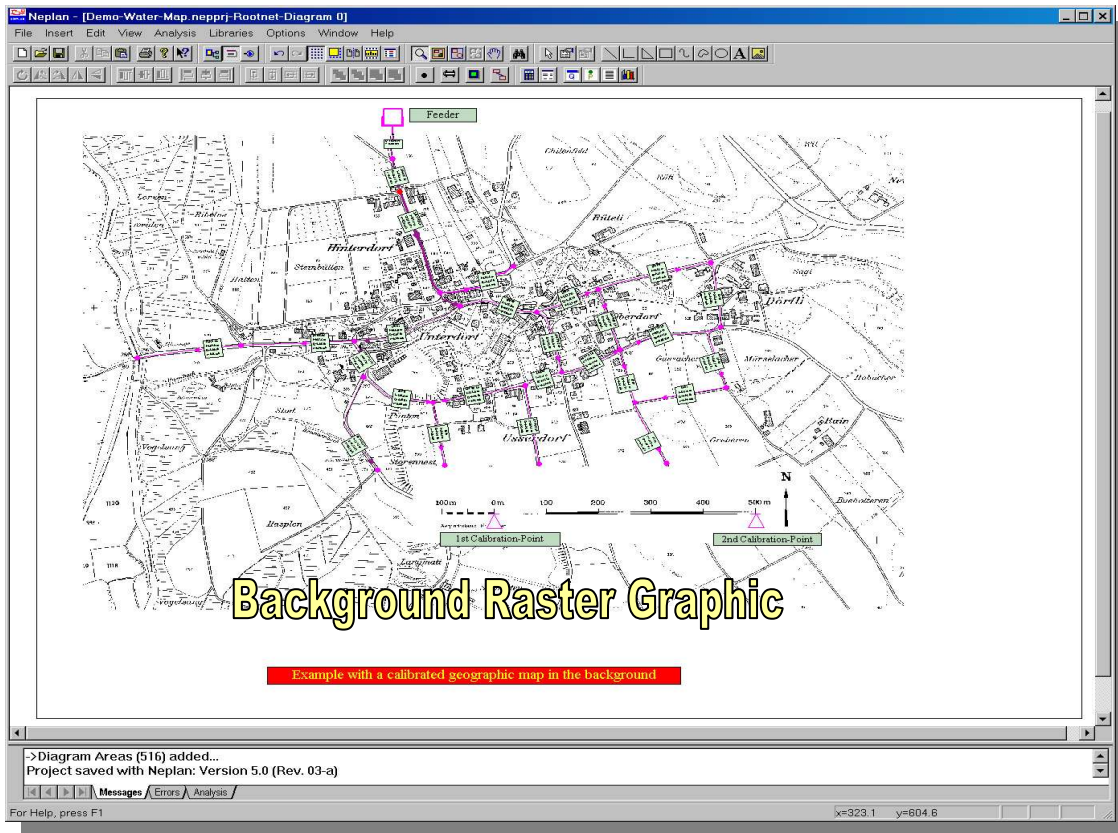

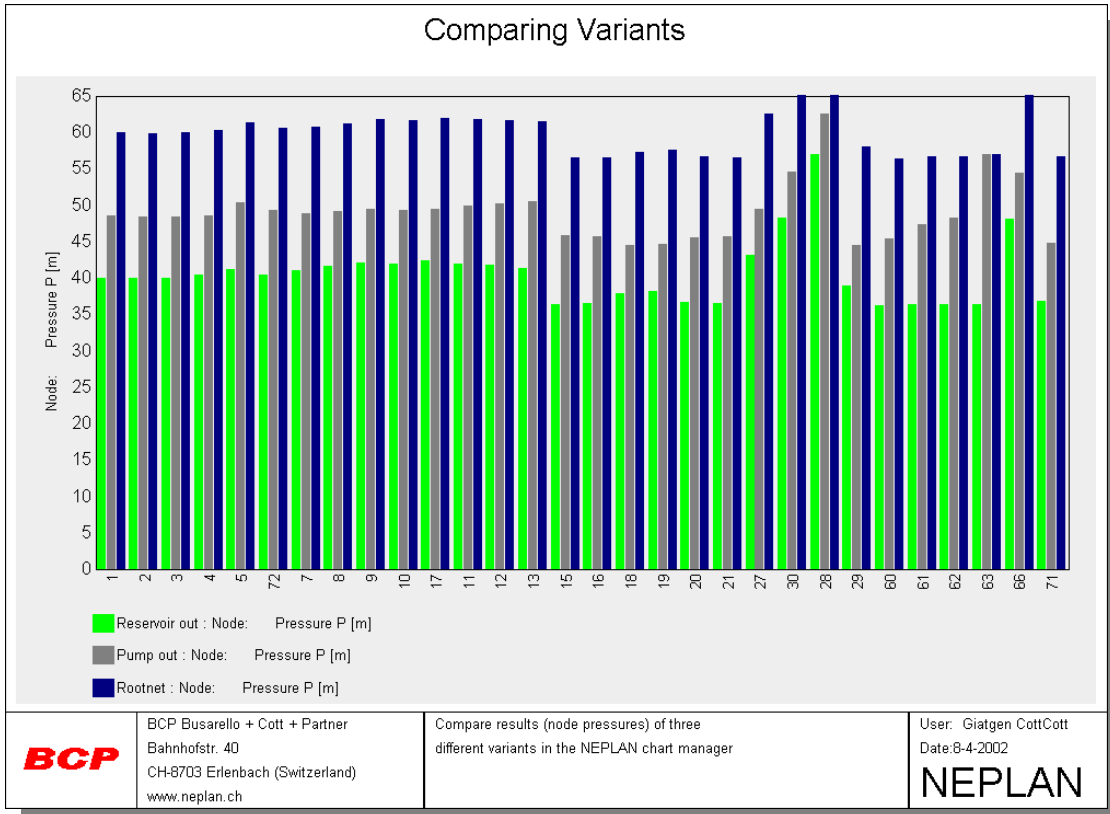

General Characteristics

- Powerful, up-to-date calculation algorithms (including Newton-Raphson and Hardy-Cross)
- Simulation of any kind and size of networks
- No restriction on number of nodes and elements
- Simultaneous calculation of any number of partial networks (independent networks)
- Calculation with load factor profiles (day, week, season, weekdays, Sundays, long term, etc.)
- Import of measured consumption data
- Changing demands through global, regional or simultaneity load factors
- To each pipe any number of line loads can be connected (e.g. houses, industrial, ...)
- Calculation of centrifugal and circulation pumps, reservoirs, valves, fittings etc.
- Sophisticated valve models
- Calculation of multiple pumps, tanks and reservoirs
- Calculation with different water temperatures
- The head loss characteristics of the pipes are calculated according to Darcy, Prandtl-Colebrook and Hagen-Poiseuille
- Time dependent load and reservoir height characteristics (e.g. at night, or at noon, summer, winter etc.)

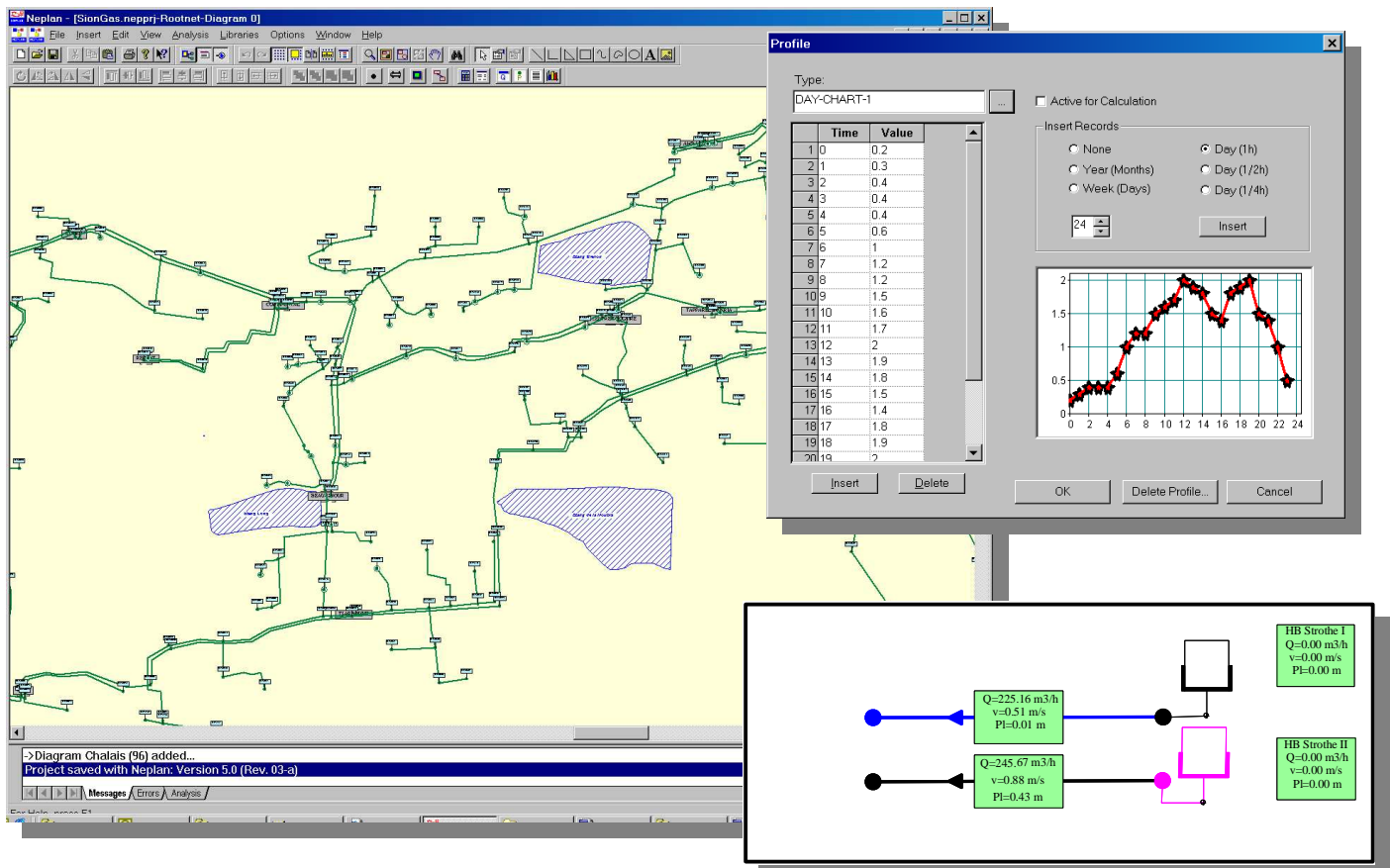

Results

- Automatic display of the results in the network diagram with many filter functions
- Coloring according to variable ranges (e.g. velocity, flow, pressure-losses, pressure etc.)
- Highlighting of overloaded elements (e.g. velocity $v > v_{max}$)
- Line width proportionally to many variables, including the flow and diameter
- Result output to an excel like table sheet, with copy/past possibilities to MS-Excel
- Output to ASCII files or SQL database for further evaluation (e.g. MS-Excel)
- Display results in a sophisticated chart manager (e.g. bar or line chart)
- Result boxes can be moved, deleted, sized, colored and hidden
- Self-defined result output: the user can select variables, font, precision, placement
- Comparing results was never easier: Results from other variants can be displayed in the same result label and in the same chart

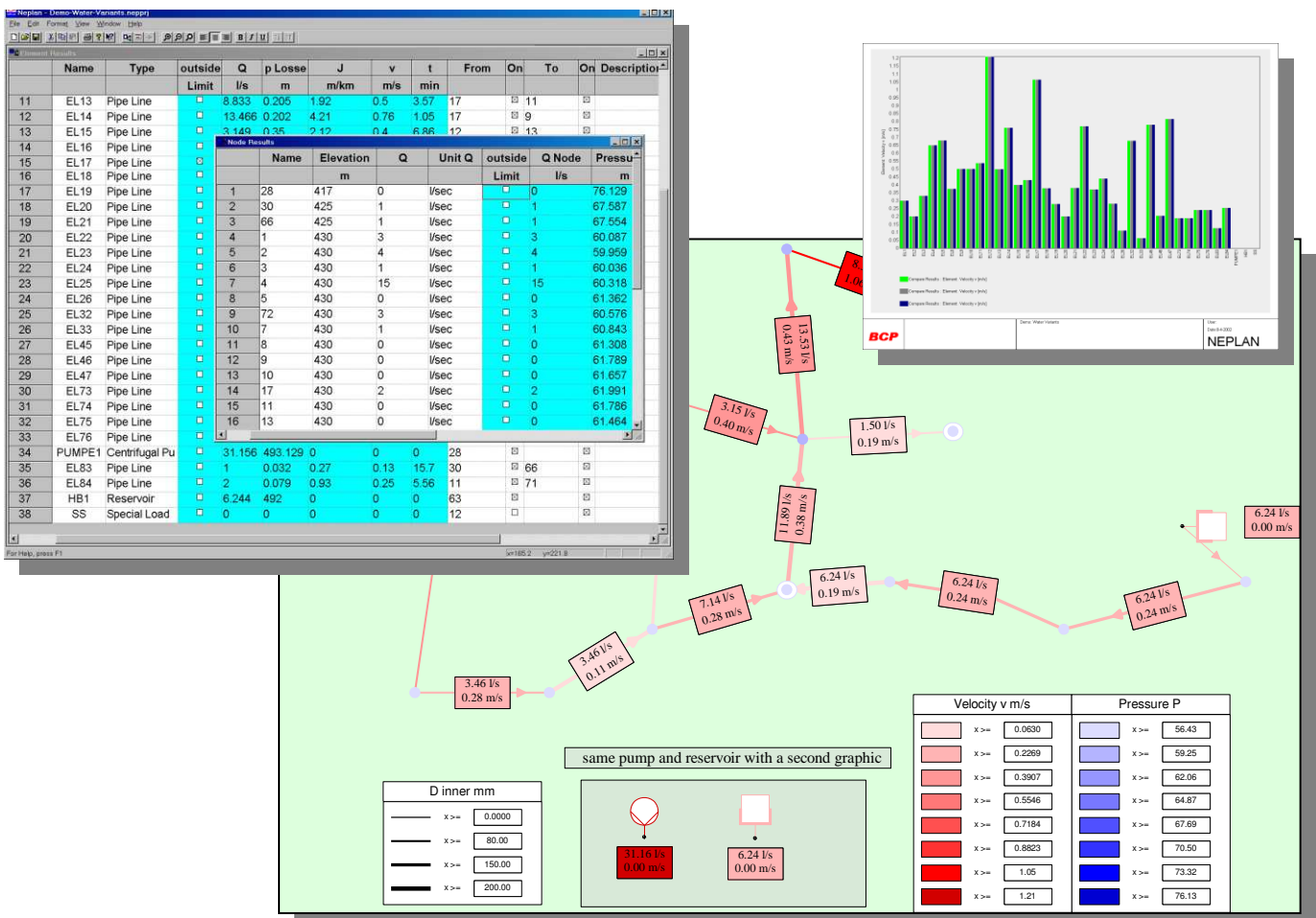

General Characteristics

- Powerful, up-to-date calculation algorithms (including Newton-Raphson and Hardy-Cross)
- Simulation of any kind and size of networks
- No restriction on number of nodes and pipes
- Simultaneous calculation of any number of partial networks (independent networks)
- Sophisticated valve and regulator models
- Calculation with load factor profiles and profiles for node demands
- Import of measured consumption data
- Changing demands through global, regional or simultaneity load factors
- To each pipe any number of line loads can be connected (e.g. houses, heating, industrial , ...)
- The head loss characteristics of the pipes are calculated according to Darcy, Prandtl-Colebrook and Hagen-Poiseuille
- Simultaneous calculation of different pressure zones (high, medium and low pressure).
- Simultaneous calculation of compressible and incompressible gases (high and low pressure)
- Free definition of load libraries (heating, cookers, industrial loads, ...) with different simultaneity factors
- Temperature dependent loads are considered

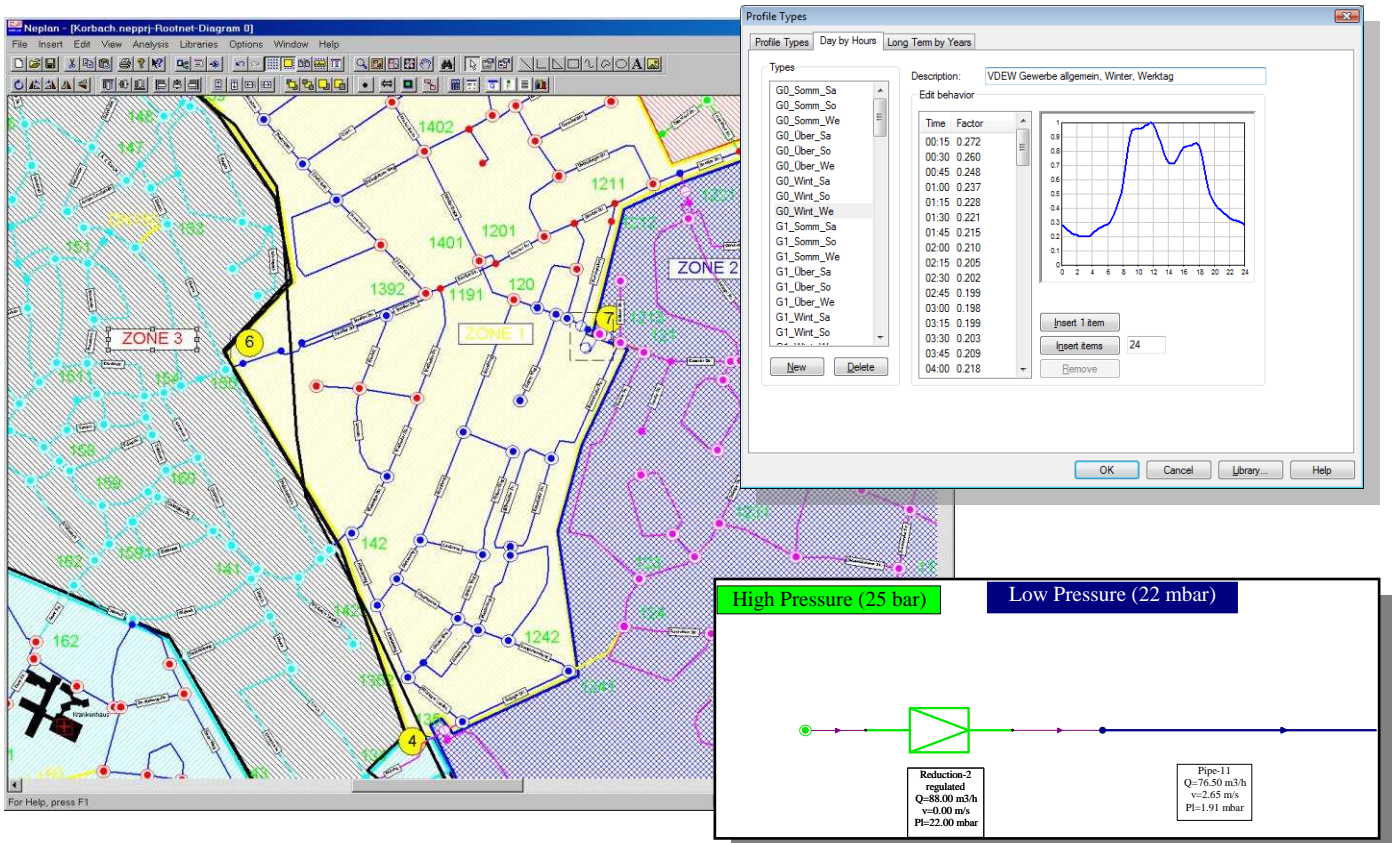

Results

- Automatic display of the results in the network diagram with many filter functions
- Coloring according to variable ranges (e.g. velocity, flow, pressure-losses, pressure etc.)
- Highlighting of overloaded elements (e.g. velocity $v > v_{max}$)
- Line width proportionally to many variables, including the flow and diameter
- Result output to an excel like table sheet, with copy/past possibilities to MS-Excel
- Output to ASCII files or SQL database for further evaluation (e.g. MS-Excel)
- Display results in a sophisticated chart manager (e.g. bar or line chart)
- Result boxes can be moved, deleted, sized, colored and hidden
- Self-defined result output: the user can select units, variables, font, precision, placement
- Comparing results was never easier: Results from other variants can be displayed in the same result label and in the same chart

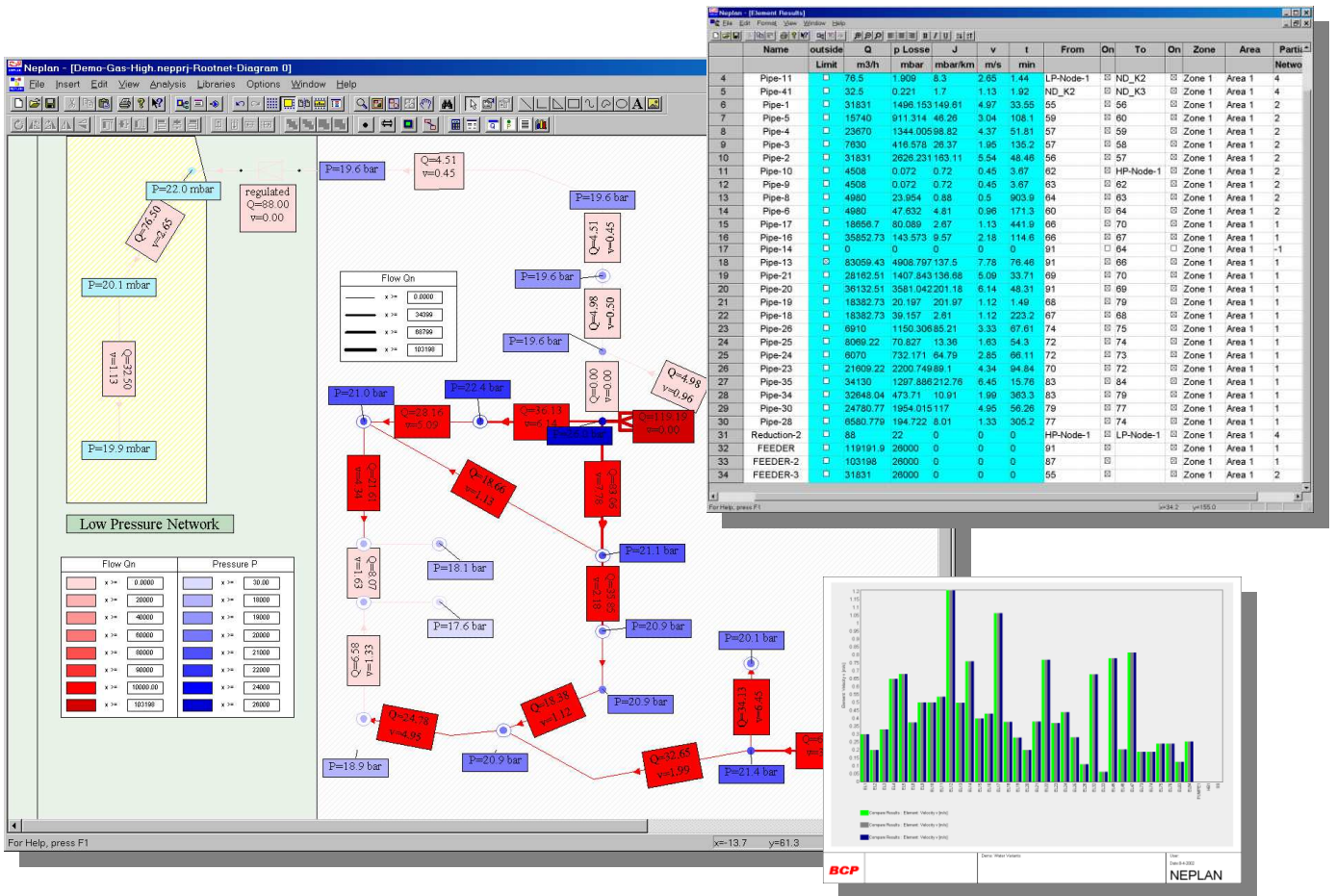

General features

- Simulation of reservoir filling and emptying process
- Defining events such as: “Start Pump if Reservoir is empty” and “Stop Pump if Reservoir is full”
- Simulation of any kind and size of networks
- No restriction on number of nodes and elements
- Simultaneous calculation of any number of partial networks
- Calculation with load factor profiles (day, week, season, weekdays, Sundays, long term, etc.)
- Import of measured consumption data
- Documentation of the processes in excel like table sheets and in user defined time diagram charts
- To each node an individual load profile can be defined (day, week, season, weekdays, Sundays, etc.)
- Considering time characteristics for reservoirs for supply, outflow and water height (day, week, season, weekdays, Sundays, long term etc.)

The image shows three overlapping windows from the NEPLAN software. The leftmost window is titled 'Profile Types' and shows a list of profile types on the left and a graph of a 'Haushalt_Sommer_Werktag' profile on the right. The middle window is titled 'Time-dependent factor: assign characteristics' and shows a table for defining seasonal and long-term factors. The rightmost window shows a network diagram with various components like pumps and reservoirs, with labels like 'different examples for 24 hours time simulation' and 'Reservoir with variable pressure'.

Load Profile

The image shows two overlapping windows from the NEPLAN software. The left window is titled 'Neplan - [Results]' and displays four charts showing simulation results for flow (Q [l/s]) and water height (Wasser [m]) over a 24-hour period. The right window is titled 'Define events for variables' and contains a table with the following data:

Active	Variable	= <>	Value	Value of Element-ID	Name	Off On	Off/On Element-ID	On/Off Nam
1				0		Off	353	EL4
2	<input checked="" type="checkbox"/>	Time h	=	4	401	On	216	12
3	<input checked="" type="checkbox"/>	Q l/s	>	12	496	On	486	PUMPE1
4	<input checked="" type="checkbox"/>	Hres m	=	-33	486	On	353	EL4
5	<input checked="" type="checkbox"/>	Q l/s	<	490.5	204	Off	357	EL5
6	<input checked="" type="checkbox"/>	P m	<	485	204	On	357	EL5

Defining Events

Results in the chart manager

Interactive Distribution, Portion of Feeders

- Display the minimal and maximal time which the gas/water has to flow from any user defined starting node to all other nodes in the diagram.
- Interactive distribution: Interactive animation of the gas / water / district heating flow through the network (evaluation of water pollution, evaluation of gas odorization). The user can see interactively how the gas/water flows through the network.
- Portion of feeders: Evaluation of the mixture of the medium for every consumer. Each consumer knows exactly from which feeding element (pump, reservoir, compressor or regulator) the gas/water/district heating is supplied. The portion from each feeding element will be displayed in the label of each node of the network.

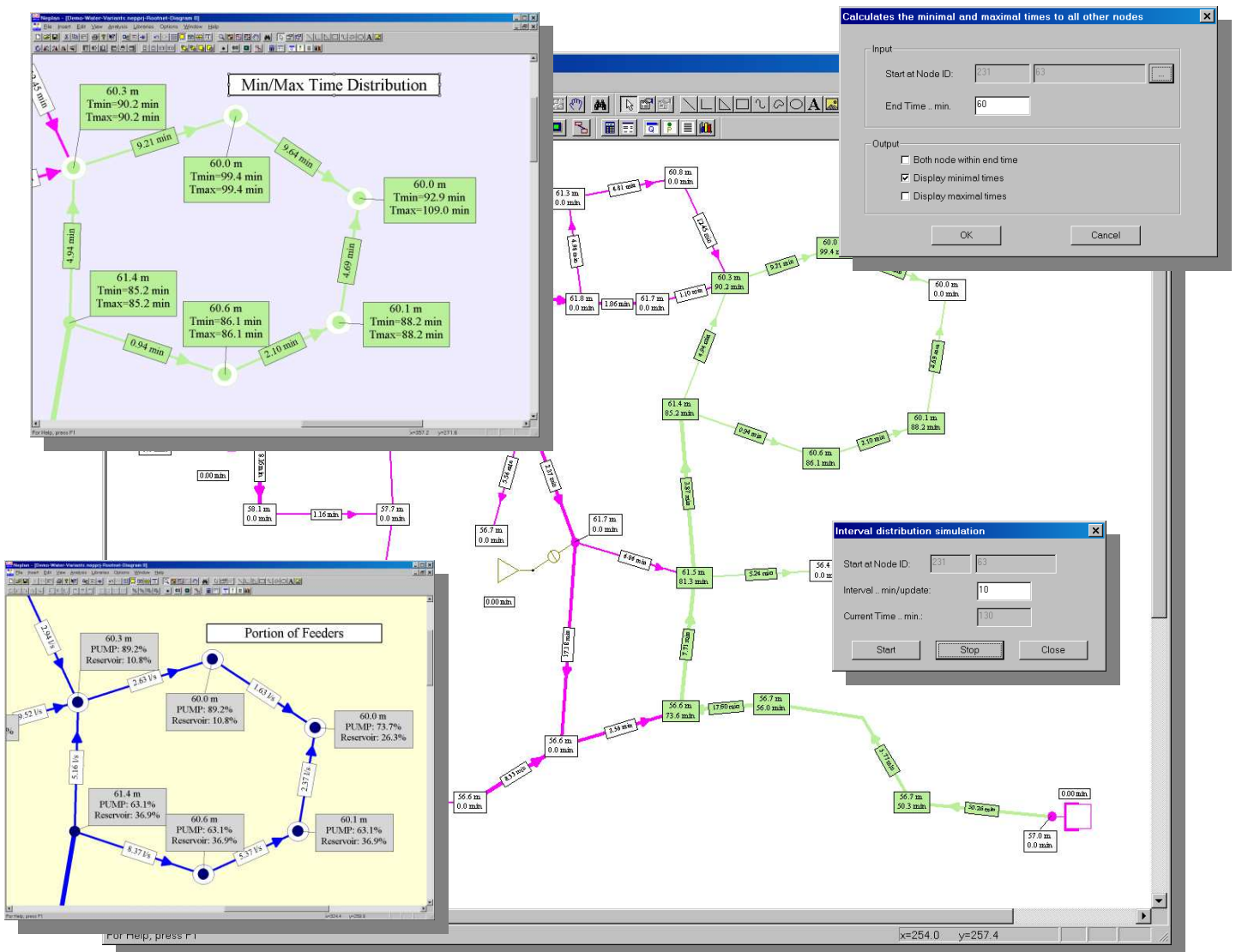

2D-Profiles

- Display a two dimensional profile in a chart of any selected pipes in the network
- Copy/Paste to the clipboard for documentation in MS-Word
- Color the selected pipes in the diagram
- The elevation and the absolute pressure is displayed in the chart
- The chart displays the correct proportion of the line length and the elevation
- Export the chart to a *.JPG file for any internet browser

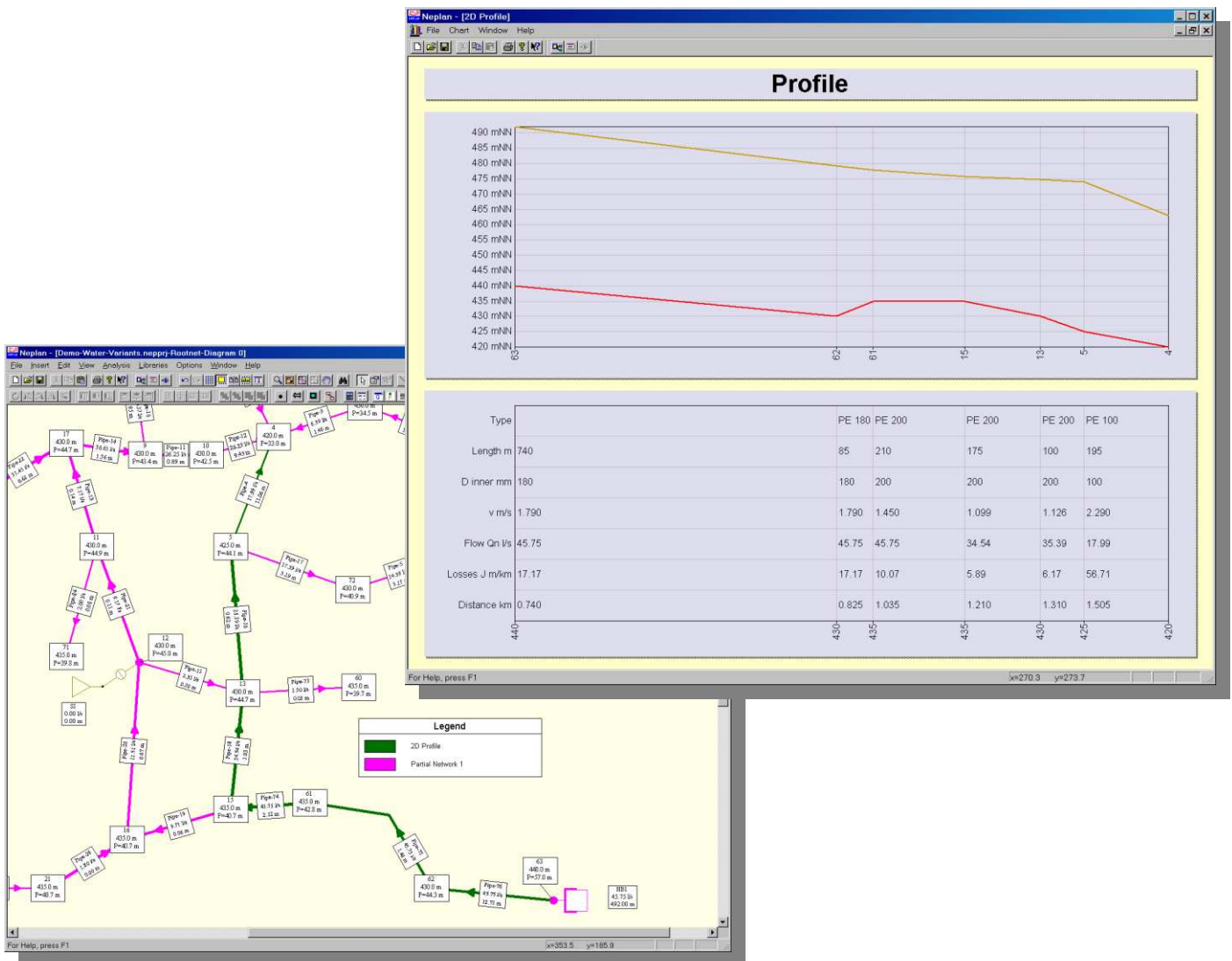

Fire Fighting Water Plan



- Automatic calculation of all node pressures with a given fire water demand Q
- Automatic calculation of all fire water demands of all nodes with a given node pressure P
- Coloring the diagram according to the results (demand Q or pressure P)
- Display the results in Excel like list format for user defined report generation
- Display the result in charts (with copy/paste possibility to MS-Word)
- Calculate all relevant data for one fire fighting water case (e.g. max. velocity and the respective pipe, min pressure and the respective node etc.)

Fire fighting water plan
 with fixed consumption Q = 48 m³/h.
 Coloring according to node pressure P [m]

	P Absolute	P Losses	t min	t max	Qfire	Pfire	Converged	PFireMin	PminBusID	VmaxFire	VmaxEleID	Descr
	m	m	min	min	l/s	m		m		m/s		
1	492.671	-0.671	0	0	0	0	1	54.189	233	1.79	473	
2	492.333	-0.333	0	0	13.333	59.881	1	54.199	233	0.85	397	
3	492.353	-0.353	0	0	13.333	63.925	1	54.199	233	0.85	397	
4	491.023	0.977	0	0	13.333	56.797	1	54.141	228	1.52	377	
5	490.856	1.144	0	0	13.333	54.31	1	54.099	228	1.55	397	
6	490.81	1.19	0	0	13.333	53.888	1	53.868	205	1.69	397	
7	490.874	1.126	0	0	13.333	54.508	1	54.059	228	1.81	397	
8	491.879	0.321	0	0	13.333	59	1	53.98	228	0.97	377	
9	491.846	0.154	0	0	13.333	59.189	1	54.2	233	0.88	377	
10	491.884	0.116	0	0	13.333	59.148	1	54.101	233	0.86	377	
11	492.004	-0.004	0	0	13.333	59.151	1	54.153	233	0.85	397	
12	491.807	0.193	0	0	13.333	58.324	1	54.189	233	1.17	385	
13	491.886	0.114	0	0	13.333	58.702	1	54.172	233	1.21	385	
14	491.804	0.396	0	0	13.333	56.183	1	54.188	228	1.28	369	
15	491.331	0.969	0	0	13.333	55.336	1	54.172	228	1.29	377	
16	491.162	0.838	0	0	13.333	56.14	1	54.042	228	2.03	397	
17	491.819	0.381	0	0	13.333	58.754	1	53.994	228	1.02	377	
18	492.359	-0.359	0	0	13.333	69.269	1	54.199	233	0.85	397	
19	491.79	0.21	0	0	13.333	54.318	1	54.273	228	0.91	377	
20	491.873	0.127	0	0	13.333	53.516	1	53.516	222	0.89	377	
21	492.391	-0.391	0	0	13.333	54.033	1	54.033	221	1.01	453	
22	492.226	-0.226	0	0	13.333	54.233	1	54.184	233	0.85	397	
23	491.787	0.213	0	0	13.333	54.353	1	54.273	228	0.91	377	
24	491.787	0.233	0	0	13.333	54.381	1	54.276	228	0.92	377	
25	491.837	0.163	0	0	13.333	50.828	1	50.828	233	1.89	477	
26	492	0	0	0	0	0	0	0	-1	0	0	

P Fire fighting

<div style="width: 20px; height: 15px; background-color: #d9ead3; border: 1px solid black;"></div>	x >=	50.83
<div style="width: 20px; height: 15px; background-color: #c7e9c0; border: 1px solid black;"></div>	x >=	52.70
<div style="width: 20px; height: 15px; background-color: #a1d99b; border: 1px solid black;"></div>	x >=	54.57
<div style="width: 20px; height: 15px; background-color: #74c476; border: 1px solid black;"></div>	x >=	56.44
<div style="width: 20px; height: 15px; background-color: #41ab5d; border: 1px solid black;"></div>	x >=	58.31
<div style="width: 20px; height: 15px; background-color: #238b45; border: 1px solid black;"></div>	x >=	60.18
<div style="width: 20px; height: 15px; background-color: #006400; border: 1px solid black;"></div>	x >=	62.05
<div style="width: 20px; height: 15px; background-color: #003366; border: 1px solid black;"></div>	x >=	63.92

0.00 m³/h
 61.8 m
 Qfire=48.00 m³/h
 Pfire=58.3 m
 Pmin=54.2 m
 IDPmin=233
 Vmax=1.17 m/s
 IDVmax=385

Calculation

- Calculation with time dependent load profiles (day, week, season, weekdays, Sundays, long term etc.)
- Import of measured consumer data from an existing in-house database.
- Loads (consumers) can be changed through 3 different load factors (general, regional or simultaneity load factors).
- To each pipe any number of line loads can be connected (e.g. houses, heating ...). Importing of consumers from existing databases (e.g. from an accounting database) is possible.
- All load and simultaneity factors of the line loads are considered during the calculation.
- The consumptions can be entered in different units (e.g. l/s m³/h, kW, t/h, etc).
- Simultaneous calculation of multiple partial networks (independent networks).
- Calculation of heat exchanger, heat plant, centrifugal and circulation pumps, reservoirs, valves, fittings, pressure regulators, etc.
- All elements have a temperature dependent thermo hydraulic model.
- It is possible to calculate only the forward flow. The return network must not be entered.
- It is possible to enter also the return network and calculate the forward and return network together.
- The calculation can be done without temperature losses. This can help to debug the network model.
- A powerful up-to-date calculation algorithm (Extended Newton Raphson) is implemented. This allows very easily inserting new element models. The complexity of the models is no longer restricted.
- The head loss characteristics of the pipes are calculated according to Prandtl-Colebrook and Hagen-Poiseuille.
- A load libraries (household, industrial loads ...) with different simultaneity factors can be defined.
- Sophisticated pump and valve models, which allows regulating pressure, flow, pressure differences at any node or element.

The screenshot displays the NEPLAN software interface. On the left, a network diagram shows 'Network 1' connected to a 'Station' and another 'Network 1'. The diagram includes various components like pipes, pumps, and regulators, with associated data such as flow rates (Q), pressure losses (p), and temperatures (T). A 'Regulation: p VL = 8 bar' and 'Regulation: p VL = 2 bar' are indicated. Below the diagram, a 'Regulation Flow Q' section is visible.

On the right, a 'Profile Types' window is open, showing a list of profile types and a graph of 'Time Factor' over a 24-hour period. The graph shows a typical daily load profile with peaks during the day and troughs at night.

At the bottom, the 'Neplan - [Element Results]' window displays a table of results for various elements in the network.

ID	Name	Type	outside Limit	Q t/h	p bar	Losse bar/km	J	v m/s	t min	T losse °C	Rho kg/m3	ny 10E-6 m2/s	Temp °C	kW losse	kW
1	175206	R-175206 Pressure Regul	0	2	0	0	0	0	0	0	984.1	0.481	59.18	0	
2	175180	L-175180 Pipe Line	59.986	0.178	0.18	0.56	29.6	0.789	941.9	0.242	122	56			
3	175327	L-175327 Pipe Line	62.653	0.847	0.85	1	16.65	0.68	983.8	0.476	59.86	49.86			
4	175357	L-175357 Pipe Line	10.027	0.005	0.02	0.17	19.93	1.866	942.5	0.244	121.21	22.24			
5	175363	L-175363 Pipe Line	10.465	0.005	0.03	0.17	19.93	0.816	983.7	0.475	60	10			
6	175191	F-175191 Heat Plant	62.674	0.25	0	2.25	0	0	984.1	0.481	59.18	0			
7	175297	F-175297 Heat Exchanger	50	4.098	0	1.88	0	0	942.5	0.244	121.21	3607.59			
8	175374	F-175374 Heat Exchanger	10.042	4.088	0	0.38	0	0	59.345	944	0.248	119.34	701.95		
9	175520	CP-1755 Circulation Pum	62.674	5.372	0	0	0	0	984.1	0.481	59.18	0			

Results

- Automatic display of the results in the network diagram with many filter functions
- Coloring according to variable ranges (e.g. velocity, flow, pressure-losses, pressure etc.)
- Highlighting of overloaded elements (e.g. velocity $v > v_{max}$)
- Line width proportionally to many variables, including the flow and diameter
- Result output to an excel like table sheet, with copy/past possibilities to MS-Excel
- Output to ASCII files or SQL database for further evaluation (e.g. MS-Excel)
- Display results in a sophisticated chart manager (e.g. bar or line chart)
- Result boxes can be moved, deleted, sized, colored and hidden
- Self-defined result output: the user can select units, variables, font, precision, placement
- Comparing results was never easier: Results from other variants can be displayed in the same result label and in the same chart
- Display the temperature, temperature losses and power losses in the diagram and in excel like table sheet

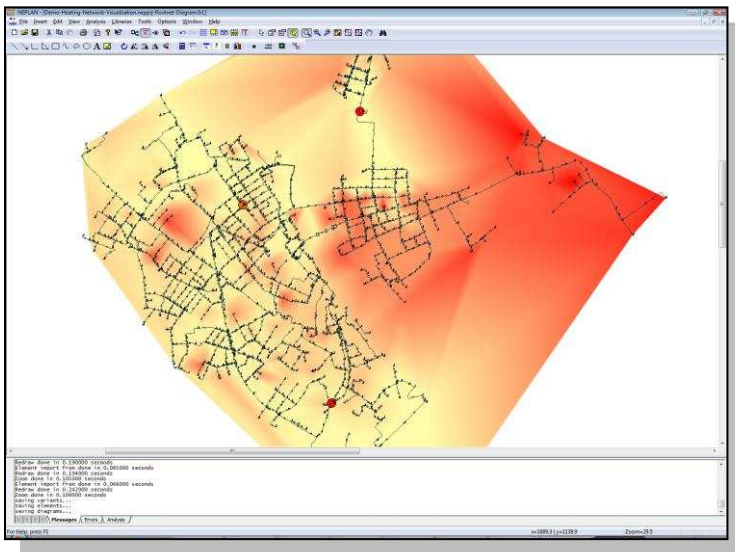

- 1) Visualization of the temperature distribution
- 2) Pipes with high velocities are especially highlighted, to give the user a quick overview about the weak points in the network

Temp	Rho	Nue	Cp	p
Celsius	kg/m3	m2/s * E.6	J/(kgK)	
1 1	1000.5	1.7281	4207.4	0.00
2 2	1000.5	1.6712	4204.5	0.00
3 3	1000.6	1.6171	4201.8	0.00
4 4	1000.6	1.6659	4199.2	0.00
5 5	1000.6	1.617	4196.9	0.00
6 6	1000.6	1.4705	4194.8	0.00
7 7	1000.6	1.4254	4192.8	0.01
8 8	1000.5	1.3844	4190.9	0.01
9 9	1000.4	1.3443	4189.2	0.01
10 10	1000.3	1.306	4187.7	0.01
11 11	1000.3	1.2694	4186.3	0.01
12 12	1000.1	1.2345	4185	0.01
13 13	1000	1.2011	4183.8	0.01
14 14	999.9	1.1692	4182.8	0.01
15 15	999.8	1.1385	4181.8	0.01

Temperature dependent medium (water) table

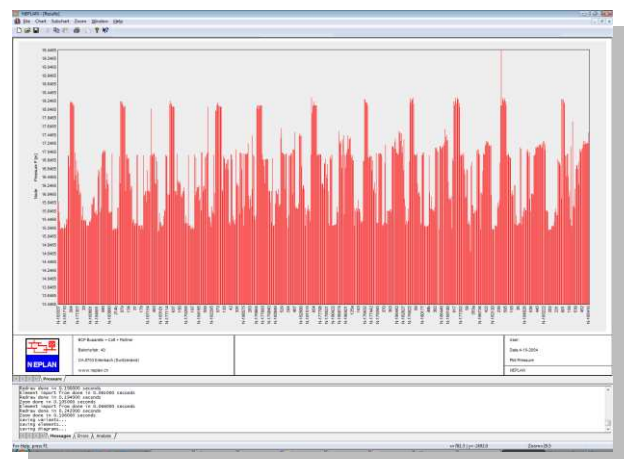

Chart with all node pressures

Additional Modules

Application: Gas – Water – District Heating



Height Interpolation

- A sophisticated height interpolation module is able to interpolate the heights (elevations) of the nodes with only a few given predefined heights. These heights can be defined either in some selected nodes, or with a few height reference elements or even from an external XYZ ASCII file.

Line Length Calculation

- The line length calculation module calculates the line length according to the real coordinates of the pipes and the scale of the diagram.

Investment Analysis

- The "Investment analysis" module is available, which calculates the investments according to a present time model.

Auto-Router

- If only the topological data of a network is available without the graphic, then it is possible to use the "Auto-Router" module, which creates the layout of the single line diagram automatically.

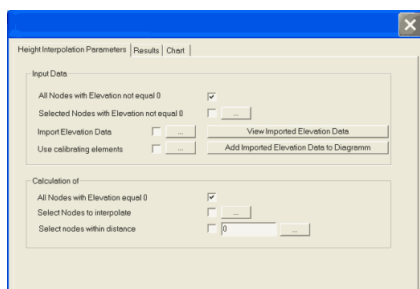

Height Interpolation Parameters

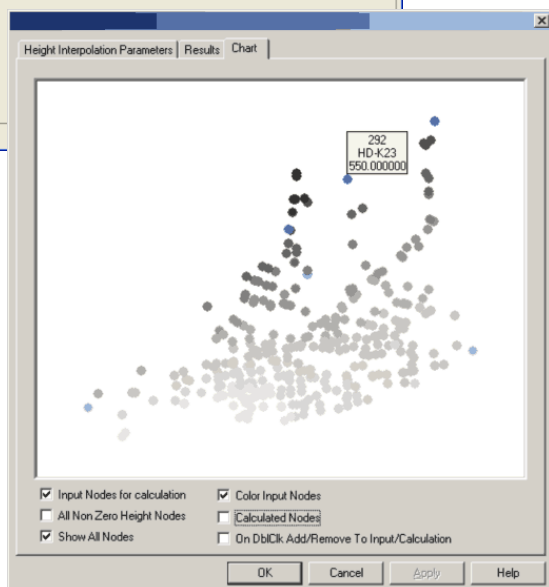

Sophisticated Height Interpolation Module

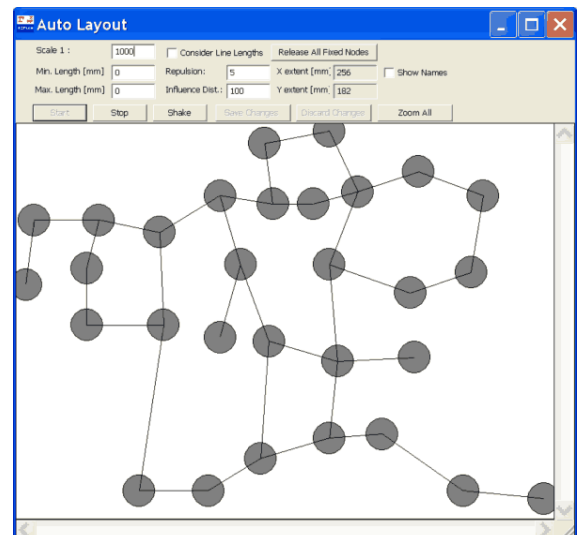

Auto-Router Module

NEPLAN Programming Library (NPL)

Application: Gas – Water – District Heating



NPL - NEPLAN Programming Library

The NPL – NEPLAN Programming Library is a C/C++ API library, which includes functions to access NEPLAN data and calculation algorithms through a C/C++ user written program. Functions included among others are:

- Access any variable of any component
- Change any variable of any component
- Execute any analysis/calculation function
- Retrieve the calculation results
- Add new components to the network
- Delete components from the network
- Add and change the graphical information (x, y coordinates, symbols, etc.) of any component

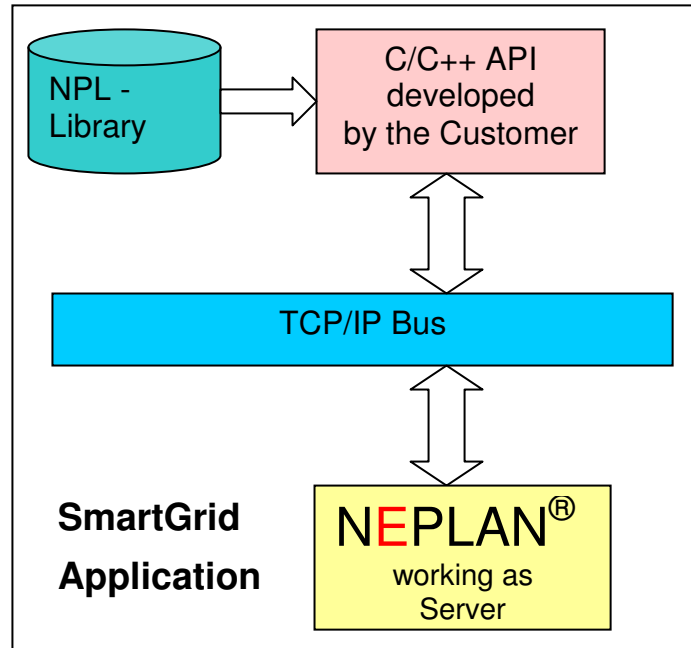

NPL - Applications

Many customized applications are possible:

- Implement NEPLAN with a NPL application in a SmartGrid environment
- Use NEPLAN in batch mode (e.g. running several load flows and short circuit calculations cases)
- Build customized interfaces (e.g. GIS, SCADA/DMS, DACF, CIM, etc.)
- Develop a network master controller with events (such as “if $u < 90\%$ switch on reserve generator”) and run the application in a quasi stationary mode
- Checking protection behavior under various network conditions
- Use NEPLAN as server and connect NEPLAN to a TCP/IP bus. The client may send any NPL command to the NEPLAN server (e.g. run load flow, open switch, change load, etc)
- Use NEPLAN as On-line system and build a DMS application using the NEPLAN graphic editor and the analysis tools
- Researchers may even develop their own calculation algorithms (e.g. OPF, reliability, capacitor placement etc.)
- and much, much more.....

NPL – C++ Program example

```
//C ++ NPL Programm
void RunTestNPL()
{
    //Open a NEPLAN project file
    OpenNeplanProject(_T("NeplanDemoProject.nepprj"));
    //run initial load flow
    RunAnalysisLF();
    //change the line length of line 'Line-1' to 0.5 km
    unsigned long ElementID=0;
    GetElementByName(_T("LINE"),_T("Line-1"), ElementID);
    if (ElementID > 0)
        SetParameterDouble(ElementID, _T("Length"), 0.5);
    //run load flow with changed line length
    RunAnalysisLF();
}

This colour means these are C++ NPL library functions
```

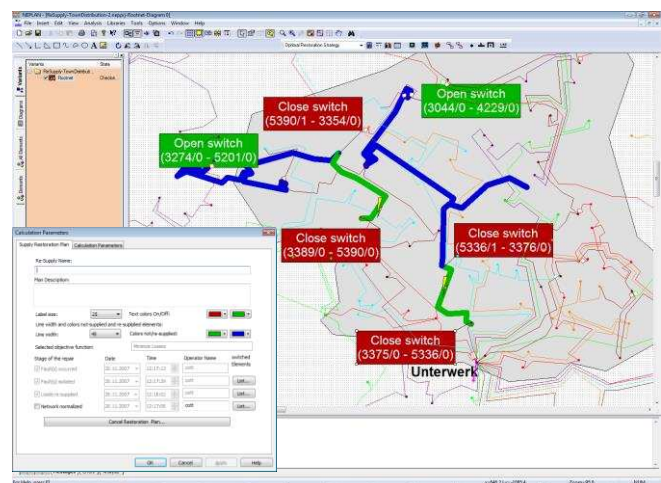

On-line DMS application: Optimal restorations after a fault

NEPLAN® Toolbox for Power Systems

The NEPLAN® Toolbox has been especially designed for **researchers and developers** which need to develop new power system models (e.g. control strategies) and new algorithm (e.g. SmartGrid applications). The Toolbox includes:

1. The **NPL NEPLAN Programming Library**, which is a C/C++ API that allows to access NEPLAN data and calculation algorithms through a C/C++ written program API functions included are amongst others:
 - execute any NEPLAN calculation engine
 - read/write access to all variables of all components
 - add / change /delete components and graphical data
 - retrieve the results from the NEPLAN analysis
2. An easy to use C/C++ API that allows developing user defined **models for load flow** calculations
3. A function block drawing editor, which allows to develop user defined models for controllers and primary components with function blocks
4. A **Matlab® interface**, which allows developing dynamic user defined models (controllers and primary components). The models may also be developed through the NEPLAN block diagram editor
5. A **Simulink® interface**, that allows to execute simultaneously the NEPLAN dynamic simulator and the Simulink® simulator. That means the controllers and/or primary components developed in Simulink® may be directly connected to a NEPLAN user defined model. When running the dynamic simulation in NEPLAN, then NEPLAN connects automatically to Matlab® and executes the Simulink® model in Matlab®. The rest of the network model will still be calculated in NEPLAN

NEPLAN® Toolbox for Researchers

- NPL - NEPLAN® Programming Library, a C/ C++ API to develop user defined algorithms
- C/ C++ API for user defined Loadflow models
- Function block diagram editor to defined dynamic models for controllers and primary components
- Matlab® interface for user defined dynamic modelling of components and controllers
- Simulink® interface for running dynamic models/controllers in Simulink® together with NEPLAN®

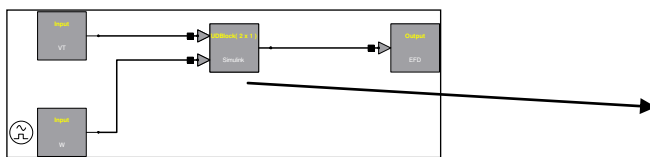

This NEPLAN function block uses the Simulink® controller.

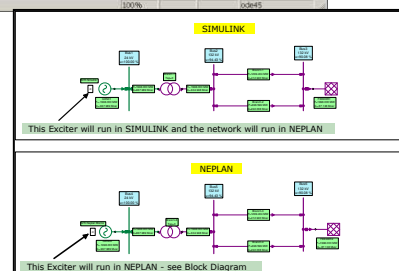
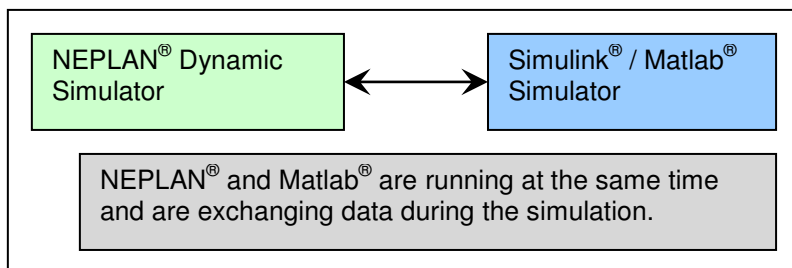
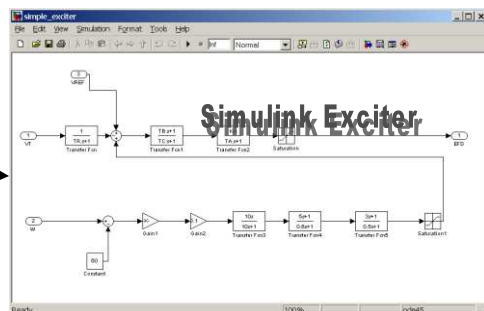

More information and free DEMO at www.neplan.ch